

Service Handbook

Premium Condensing Residential Gas Tankless Water Heaters

Residential On-Demand Gas Tankless Water Heaters

(X3™ TECHNOLOGY available on some models)



MODELS:

THR-160M, THR-180M, THR-199M
THR-160X3, THR-180X3, THR-199X3

THIS SERVICE HANDBOOK IS FOR USE BY QUALIFIED PERSONS ONLY.

TABLE OF CONTENTS

BASICS.....	2	Flame Sensor Wire Replacement Kit Instructions	47
COMPLETED INSTALLATION (STANDARD MODEL)	3	Freeze Protection Thermostat Replacement Kit Instructions.....	48
SAFETY	5	Main Wiring Harness Replacement Kit Instructions	49
OPERATION	8	Gas Wiring Harness Replacement Kit Instructions	53
Tools Required for Servicing Residential Gas Tankless Models	8	Flue/Air Intake Clamp Replacement Kit Instructions	55
User Interface Display.....	9	Emission Port Cap Replacement Kit Instructions.....	56
Temperature Adjustment/Setting the Temperature	10	Gas Connector Replacement Kit Instructions	57
Unit Conversion Mode.....	11	Pressure Switch Replacement Kit Instructions	59
Configuration Mode for Pump and Temperature Settings (A-Mode)	12	Flame Sensor Assembly Replacement Kit Instructions.....	60
Configuration Mode (C-Mode)	13	Ignitor rod Assembly Replacement Kit Instructions	62
Information Mode (P-Mode)	14	Ignitor Assembly Replacement Kit Instructions.....	64
Setting the Clock.....	16	Gas Valve Replacement Kit Instructions	65
Setting Recirculation Mode and Recirculation Type	17	Fan Assembly Replacement Kit Instructions.....	67
Setting the Pump Timers	19	Venturi & Gas Tube Replacement Kit Instructions.....	70
Pump Timer Activation	20	Burner Replacement Kit Instructions.....	73
COMPONENT DATA.....	21	Heat Exchanger Replacement Kit Instructions.....	78
Ignitor Rod	21	Inlet Filter Replacement Kit Instructions	85
Pressure Switch	21	Water Pump & Tubing Replacement Kit Instructions	86
Hi-Limit Switch (Manual)	21	Air Intake Water Trap Replacement Kit Instructions.....	90
Hi-Limit Switch (Burner Door)	21	Water Pump & Tubing Replacement Kit Instructions	91
Gas Valve (SIT)	22	HEX Inlet & Outlet Tube Replacement Kit Instructions.....	95
Recirculation Pump.....	22	Water Piping Replacement Kit Instructions	99
Propane Gas Conversion Diaphragm	23	Bypass Valve & Tubing Replacement Kit Instructions	102
Cascade System	24	Flow Control Valve Replacement Kit Instructions.....	105
TROUBLESHOOTING	28	Inlet Assembly Replacement Kit Instructions	107
General Troubleshooting	28	Outlet Assembly Replacement Kit Instructions	110
Error Codes	30	Condensate Trap Replacement Kit Instructions.....	112
Fault Analysis of Error Codes	30	Cartridge Manifold and Outlet Tee Replacement Kit Instructions.....	115
Descaling	38	Fastener Master Replacement Kit Instructions.....	118
SERVICE	40	O-Ring Replacement Kit Instructions.....	121
User Interface Module/Control Board Replacement Kit Instructions.....	40	COMPONENT LIST.....	123
Burner Door Hi-Limit Replacement Kit Instructions	43	WIRING DIAGRAM.....	130
Heater Block Wiring Assemblies Replacement Kit Instructions.....	44	THERMISTOR RESISTANCE VS TEMPERATURE CHARTS	131
		NOTES	132

Typical Installation

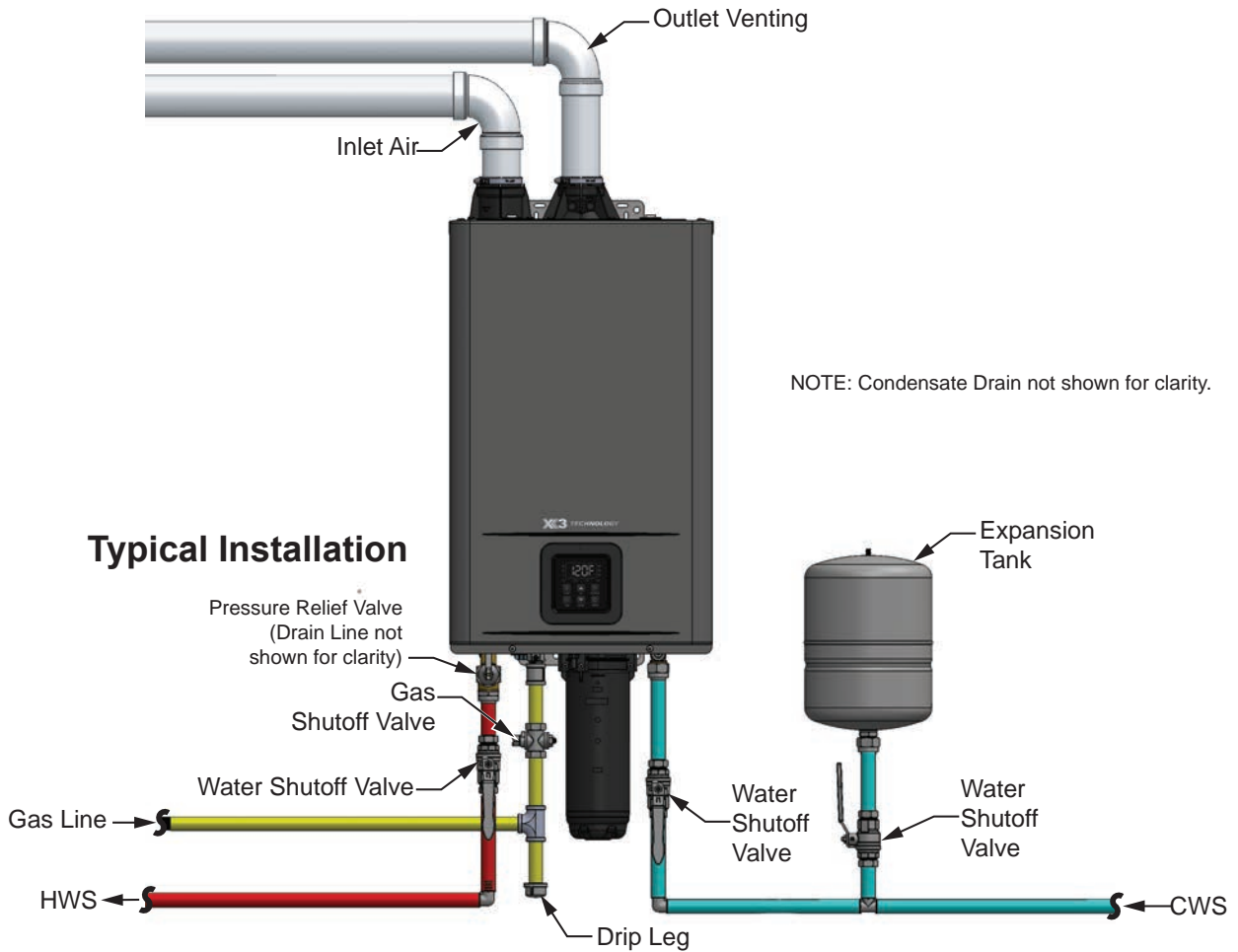

Dedicated Return Line

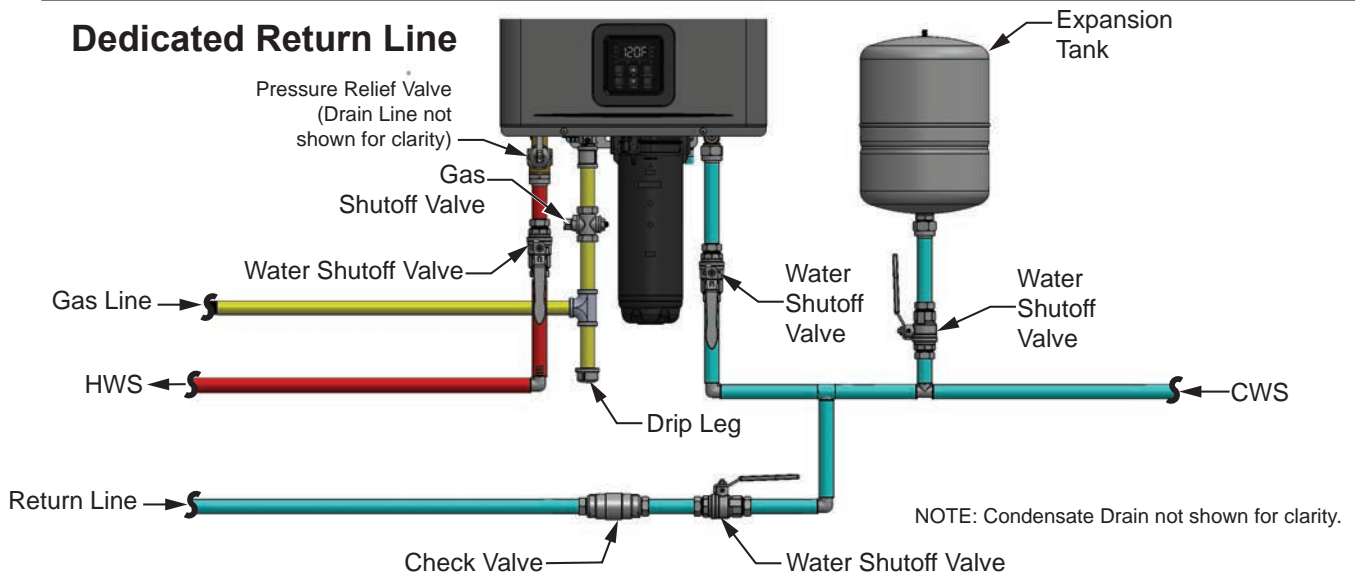





THIS PAGE INTENTIONALLY BLANK

IMPORTANT SAFETY INFORMATION

Read and follow all safety messages and instructions in this manual.

	<p>This is the safety alert symbol. It is used to alert you to potential physical injury hazards. Obey all safety messages that follow this symbol to avoid possible property damage, serious injury or death. Do not remove any permanent instructions, labels, or the data plate from either the outside of the water heater or on the inside of the access panels. Keep this manual near the water heater.</p>
---	---

	<p>DANGER indicates a hazardous situation that, if not avoided, will result in death or serious injury.</p>
	<p>WARNING indicates a hazardous situation that, if not avoided, could result in death or serious injury.</p>
	<p>CAUTION indicates a hazardous situation that, if not avoided, could result in minor or moderate injury.</p>
	<p>NOTICE indicates practices not related to physical injury.</p>

Important information to keep

Fill out this section and keep this manual in the pocket of the water heater for reference.

Date Purchased:

Model Number:

Serial number:

Maintenance performed:*	Date:

**Operate the Pressure Relief Valve annually and inspect Pressure Relief Valve every 2-4 years (see the label on the Pressure Relief Valve for maintenance schedule). If no label is attached to the Pressure Relief Valve, follow the instructions in the Maintenance section of this manual. See the Regular Maintenance section for more information about maintaining this water heater.*

⚠ WARNING! If the information in these instructions is not followed exactly, a fire or explosion may result causing property damage, personal injury or death. Do not store or use gasoline or other flammable vapors and liquids in the vicinity of this or any other appliance.

An odorant is added by the gas supplier to the gas used by this water heater. This odorant may fade over an extended period of time. Do not depend upon this odorant as an indication of leaking gas. We recommend installing a fuel gas and carbon monoxide detector.

This product is certified to comply with a maximum weighted average of 0.25% lead content as required in some areas.

IMPORTANT SAFETY INFORMATION

To reduce the risk of property damage, serious injury or death, read and follow the precautions below, all labels on the water heater, and the safety messages and instructions throughout this manual.

RISKS DURING INSTALLATION AND MAINTENANCE



Lifting Risk

▲ WARNING! The water heater is heavy. Follow these

precautions to reduce the risk of property damage, injuries from lifting or impact injuries from dropping the water heater.

- Use at least two people to lift the water heater.
- Be sure you both have a good grip before lifting.
- Use an appliance dolly or hand truck to move the water heater.



Explosion Risk

▲ WARNING! Read the water heater's data

plate to determine the type of gas required. Failure to follow these instructions can result in serious injury or death from explosion, fire or carbon monoxide poisoning.

- Do not connect a natural gas water heater to an L.P. gas supply.
- Do not connect an L.P. gas water heater to a natural gas supply.
- Use a new gas supply line approved for Propane or Natural Gas that meets all local and state/provincial codes.
- Install a full port shut-off valve on the gas supply line.

- Maintain the Pressure Relief Valve properly. Follow the maintenance instructions provided by the manufacturer of the Pressure Relief Valve (label attached to Pressure Relief Valve). If no label is attached to the Pressure Relief Valve, follow the instructions in the Regular Maintenance section of this manual. An explosion could occur if the Pressure Relief Valve or discharge pipe is blocked. Do not cap or plug the Pressure Relief Valve or discharge pipe.

Gas Pressure

▲ WARNING! The gas supply pressure must not exceed the maximum supply pressure as stated on the water heater's rating plate. Have a qualified person (licensed plumber, gas company personnel, or authorized service technician) check for proper gas pressure. Gas pressures exceeding the maximum supply pressure as stated on the water heater's rating plate can result in serious injury or death from explosion or fire.

RISKS DURING OPERATION

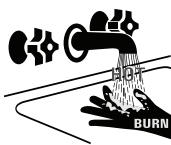

Scalding Risk

This water heater can make water hot enough to cause severe burns instantly, resulting in severe injury or death.

- Feel water before bathing or showering.
- To reduce the risk of scalding, install Thermostatic Mixing Valves (temperature limiting valves) at each point-of-use. These valves automatically mix hot and cold water to limit the temperature at the tap. Mixing valves are available at your local plumbing supplier. Follow the manufacturer's instructions for installa-

tion and adjustment of the valves.

- Water temperatures over 125°F (52°C) can cause severe burns instantly or death from scalding. The water temperature is set at 120°F (50°C) from the factory to minimize any scalding risk. Before bathing or showering, always check the water temperature. Higher temperatures increase the risk of scalding, but even at 120°F, hot water can scald. If you choose a higher temperature setting, Thermostatic Mixing Valves located at each point-of-use are particularly important to help avoid scalding.

Table 1: Burn/Scald Table

Temperature	Time to Produce a Serious Burn
120°F (49°C)	More than 5 minutes
125°F (52°C)	1½ to 2 minutes
130°F (54°C)	About 30 seconds
135°F (57°C)	About 10 seconds
140°F (60°C)	Less than 5 seconds
145°F (63°C)	Less than 3 seconds
150°F (66°C)	About 1½ seconds
155°F (68°C)	About 1 second

For more information about changing the factory temperature setting, refer to the "Temperature Adjustment/Setting the Temperature" section in this manual.

- Water temperature will be hotter if someone adjusted the set temperature to a higher setting.
- Should overheating occur or the burner fail to shut off, turn off the manual gas supply valve to the water heater and call a qualified person.

To reduce the risk of unusually hot water reaching the fixtures in the house, install Thermostatic Mixing Valves at each point-of-use.

If anyone in your home is at particular risk of scalding (for example, the elderly, children, or people with disabilities) or if there is a local code or state/provincial law requiring a certain water temperature at the hot water tap, these precautions are particularly important.

According to a national standard American Society of Sanitary Engineering (ASSE 1070) and most local plumbing codes, the water heater's thermostat should not be used as the sole means to regulate water temperature and avoid scalds.

Water Contamination Risk

Do not use chemicals that could contaminate the potable water supply. Do not use piping that has been treated with chromates, boiler seal, or other chemicals. Suitable for potable water heating only.



Fire Risk

To reduce the risk of a fire that could result in property damage, or serious injury or death:

- Do not store things that can burn easily such as paper or clothes next to the water heater.
- Do not store or use gasoline or other flammable substances in the vicinity of this or any other appliance.
- Do not use this appliance if any part has been in contact with or been immersed in water. Immediately call a qualified installer or service agency to replace a flooded water heater. Do not attempt to repair the unit. It must be replaced.



Explosion Risk

High pressures in the water heater can cause an explosion resulting in property damage, serious injury or death. A Pressure Relief Valve is required to be installed on the water heater. A Pressure Relief Valve is supplied with X3® models and shall be field supplied for M models. Additional pressure protective equipment may be required by local codes.

A nationally recognized testing laboratory maintains public inspection of the valve production process and certifies that it meets the requirements for Relief Valves for Hot Water Supply Systems, ANSI Z21.22. The Pressure Relief Valve's relief pressure must not exceed the working pressure rating of the water heater as stated on the rating plate.

Carbon Monoxide Risk



⚠ WARNING! This water heater operates by burning gas. Carbon monoxide is a colorless, odorless,

gas that is a by-product of burning of fuels such as coal, wood, charcoal, oil, kerosene, propane, and natural gas. Breathing excessive and abnormal amounts of carbon monoxide can cause carbon monoxide poisoning, resulting in serious injury or death. This water heater must be supplied with adequate combustion air and must be properly vented to the outdoors. Have a qualified person (licensed plumber, authorized gas company personnel, or authorized service technician) install the venting system using these installation instructions.

Install a fuel gas and carbon monoxide detector in the living areas of your home.

- Failure to follow these instructions can result in serious injury or death from carbon monoxide poisoning.

OPERATION

Tools Required for Servicing Residential Gas Tankless Models

- Safety gloves
- Non-contact circuit tester
- Common hand tools (screwdrivers, pliers, wire cutters, wrenches, etc.)
- 12" Phillips screwdriver
- 10mm Hex socket
- 8mm socket
- Plastic scraper
- Digital multimeter (with alligator leads and continuity tester)
- Clamp style amp meter
- Water pressure gauge
- Garden hose (draining tank)
- Bucket
- Thermometer (2x)
- Ratchet and breaker bar
- 8" and 16" socket extensions
- 5/16" nut driver for ground screws
- Pipe wrench for flex hoses and t-nipples
- Pipe joint compound or thread sealant tape
- Masking tape and a permanent marker to mark wires
- Cable ties (various sizes)
- Mini Pick or Hook
- Installation Instruction/Use and Care Guide

User Interface Display

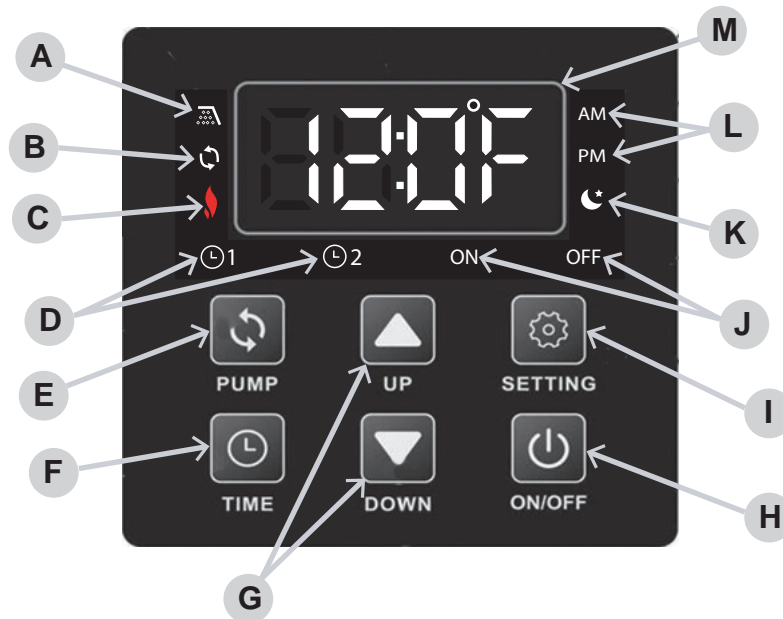

Figure 1 - User Interface Display Diagram

Table 2: User Interface Display







Item	Description
A	Water Flow Detected
B	Pump is Operating
C	Flame Detected
D	Pump Timer 1 & 2 Active
E	Pump Button
F	Time Button
G	Up & Down Buttons
H	Operation ON/OFF Button
I	Setting Button
J	Pump Timer ON/OFF Indicators (only shown when setting the Pump Timers)
K	Standby Mode
L	AM/PM for Time & Pump Timer Setting
M	Display

OPERATION

Temperature Adjustment/Setting the Temperature

With the installation steps completed, you may adjust the water heater’s temperature setting if desired. The water temperature set point is factory set to 120°F (49°C). The temperature set point may be increased or decreased in increments by simply pressing the “UP” button or the “DOWN” button. To set the water heater to a temperature above 125°F (52°C), follow the procedure below. See "Table 4: Water Heater Temperature Set Points" on page 11.

Table 3: Temperature Adjustment/Setting the Temperature

	Operation	Screen on the Controller
		Built-in Controller
1	Turn on the 120 VAC power supply to the water heater.	
2	Press the DOWN button to decrease the water temperature.	
3	Press the UP button to increase the water temperature. ⚠ WARNING! Higher temperatures increase the risk of scalding, but even at 120 °F (50 °C), hot water can scald (See "Table 1: Burn/Scald Table" on page 6). NOTE: You can only increase the water temperature to 125°F. Additional steps are required to increase the temperature above 125°F.	
4	To raise the temperature above 125°F, press and hold the SETTING button for 5 seconds then release to access the A Mode. The display will alternately flash A00 and 125°F.	
4a	Press the SETTING button again. The temperature setting will flash. You can increase the temperature above 125°F.	
4b	Press the UP button to set the desired temperature.	
4c	Press and hold the SETTING button to return the display to normal operation. The new set temperature will appear in the selected unit (Example: 130°F).	
4d	The display should show the updated temperature.	







Unit Conversion Mode

Table 4: Water Heater Temperature Set Points

°F	100	102	104	106	108	110	115	120*	125	130	135	140
°C	38	39	40	41	42	43	46	49*	52	54	57	60

Units of measure can be changed from Imperial to Metric and vice versa. For example, temperature can be changed from °F to °C. Flow rate will also change from gallons per minute to liters per minute when this setting is changed. Follow this procedure to change this setting.

Table 5: Unit Conversion

	Operation	Screen on the Controller
		Built-in Controller
1.	Turn on the 120 VAC power supply to the water heater.	
2.	Press the ON/OFF button on the controller in order to turn the controller on.	
3	The set point temperature will display as shown in the picture on the right (Example: 120°F).	
4	Press and hold the SETTING button for 5 seconds to access the water heater A Mode.	
5	The display will show code A00. Press the UP button once to display code A01. Press the SETTING button to show the current temperature setting. The temperature will flash.	
6	Press the UP button to alternate between F (Fahrenheit) and C (Celsius).	
7	Press the SETTING button to execute the change.	
8	Press and hold the SETTING button to return the display to normal operation. The new set temperature will appear in the selected unit (Example: 49°C).	

OPERATION

Configuration Mode for Pump and Temperature Settings (A-Mode)

You can configure the water heater to accommodate your application from A-Mode. Follow the procedure below to access A-Mode:

1. Press and hold the SETTING button for 5 seconds to access A Mode.
2. Press the UP button or the DOWN button to search for the desired A Code.
3. If applicable, press the SETTING button to adjust the value. When the setting flashes, use the UP or DOWN arrows to change the setting.
4. Press the SETTING button again to confirm the new value selected is correct.
5. Press and hold the SETTING button for 5 seconds to return the display to normal operation.

Table 6: A-Mode Settings

CODE	DESCRIPTION	OPTIONS							
A00	Set Temperature Setting (for High Temp.)	°F	125	130	135	140			
		°C	52	54	57	60			
A01	Temperature Unit	°F	Imperial Units of Measure						
		°C	Metric Units of Measure						
A02	Recirculation Interval Timer		5, 10(default), 15, 20, 25, 30, 40, 50, 60 min						
A03	Pump Turn On Temperature from Set Point	°F	-10	-15	-20 (default)	-25	-30	-35	-40
		°C	-6	-8	-11 (default)	-14	-17	-19	-22
A04	Pump Turn Off Temperature from Set Point	°F	-5	-10 (default)	-15	-20	-25	-30	-35
		°C	-3	-6 (default)	-8	-11	-14	-17	-19
A05	Recirculation Mode	0:	Recirculation Inactive (default)						
		1:	Recirculation Active						
A06	Recirculation Type	0:	Dedicated Return Line (default)						
		1:	Crossover Valve						
A07	CA Title 24 Mode	0:	Pump Timer Control (default)						
		1:	On Demand Control - CA Title 24						

Configuration Mode (C-Mode)

You can configure the water heater to accommodate your application from C Mode. Follow the procedure below to access C Mode:

1. Press and hold the “UP” button and the “SETTING” button for 5 seconds to access C Mode.
2. Press the “UP” button or the “DOWN” button to search for the desired C Code.
3. If applicable, press the “SETTING” button to adjust the value of the C Code using the “UP” and “DOWN” buttons. The value will flash.
4. Press the “SETTING” button again to confirm the new value selected is correct.
5. Press and hold the “UP” button and the “SETTING” button for 5 seconds to return the display to normal operation.

Table 7: C-Mode Settings

CODE	DESCRIPTION	OPTIONS	
C01	Elevation Settings	0:	0 – 1,999 (default) (0 - 609)
		1:	2,000 – 5,399 (610 - 1,645)
		2:	5,400 – 7,699 (1,646 - 2,347)
		3:	7,700 – 10,100 (2,347 -3,078)
C03	Gas Type	0:	Natural Gas (default)
		1:	Propane
C07	Power Frequency	60:	60Hz (default)
C13	Number of Child Units in Cascade System	0:	Cascade System Inactive (default)
		1-11:	Identify Number of Child Units. This activates the Cascade System
C14	Cascade System Heater ID Number	1:	Parent Heater (default)
		2-12:	Individually set each child unit per user preference
C15	Descaling Mode	Off:	Normal Operation (default)
		dScL:	Activate Descal Mode
C18	Pump High Limit Setting	60	40 - 90
		(Default)	
NOTICE: Some modes are displayed but not used.			

OPERATION

Information Mode (P-Mode)

Follow the procedure below to access P Mode:

1. Press and hold the “DOWN” button and the “UP” button for 5 seconds to access P Mode.
2. Press the “UP” button or the “DOWN” button to search for the desired P Code.
3. Press and hold the “UP” button and the “DOWN” button for 5 seconds to return the display to normal operation.

Table 8: P-Mode Settings

CODE	DESCRIPTION	VALUE
P00	Heat Exchanger water outlet temperature	Heat Exchanger water outlet temperature
P01	Water Outlet Temperature	Water outlet temperature °F / °C
P02	Water Inlet Temperature	Water inlet temperature °F / °C
P03	Water Flow	0.1*Gallon/min OR 0.1*L/min
P04	Fan Speed	The real-time Fan speed (RPM)
P07	Bypass Water Valve Position	The real-time position of bypass valve. (0 = full open; 2200 = full closed.)
P08	Main Water Valve Position	The real-time position of main valve (0 = full open; 2200 = full closed.)
P09	A/D Value Of Flame	Flame sensor signal: <ul style="list-style-type: none">• Less than 140 in Standby.• Greater than 180 under combustion. This value increases as input increases.
P10	Venturi Stepper Motor Position	The real-time position of Venturi. (0 = Stage 1; 200 = Stage 2, 380 = Stage 3)
P11	Pump Speed	Current pump speed (RPM)
P12	Most Recent Fault Code	N/A
P13	Second Most Recent Fault Code	N/A
P14	Third Most Recent Fault Code	N/A
P15	Exhaust Temperature	°F / °C
P16	Display Software Version No.	Front Board Software Version
P17	Controller Software Version No.	Main Board Software Version
P19	Model Number	199/180/160
P20	Combustion Time	Combustion Time in Hours. Estimated water volume through the water heater during combustion. The UIM will display up to 4 digits (2 second pause) and the remaining 4 digits. See Figure 2.
P21	Ignition Quantity	Number of times the ignitor has activated. The UIM will display up to 4 digits (2 second pause) and the remaining 4 digits. See Figure 2.
P23	Recirculation Pump Activation Quantity	Number of times the pump has activated. The UIM will display up to 4 digits (2 second pause) and the remaining 4 digits. See Figure 2.

CODE	DESCRIPTION	VALUE
P24	Venturi 0 Position Combustion Time	Number of time the venturi was at position 0 during combustion. The UIM will display up to 1 digit (2 second pause) and the remaining 4 digits. See Figure 2.
P25	Venturi 200 Position Combustion Time	Number of time the venturi was at position 200 during combustion. The UIM will display up to 1 digit (2 second pause) and the remaining 4 digits. See Figure 2.
P26	Venturi 380 Position Combustion Time	Number of time the venturi was at position 380 during combustion. The UIM will display up to 1 digit (2 second pause) and the remaining 4 digits. See Figure 2.
P27	Estimated Water Volume Through-Put (During Combustion)	Estimated water volume through the water heater during combustion. The UIM will display up to 4 digits (2 second pause) and the remaining 4 digits. (x 100 gal) See Figure 2.
P28	Stage 3 Max Fan Speed	Factory Setting (RPM)
P29	Stage 3 Min Fan Speed	Factory Setting (RPM)
P30	Stage 2 Max Fan Speed	Factory Setting (RPM)
P31	Stage 2 Min Fan Speed	Factory Setting (RPM)
P32	Stage 1 Max Fan Speed	Factory Setting (RPM)
P33	Stage 1 Min Fan Speed	Factory Setting (RPM)
NOTICE: Some modes are displayed but not used.		



EXAMPLE:









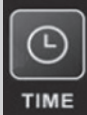

Join the two values (not add) to create the total: 231,971 then x 100 will yield 23,197,100 gallons.

Figure 2 - Combining multiple display value data. Both 8 and 5 units.

OPERATION



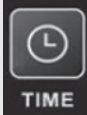





Setting the Clock

Table 9: Clock Setting

	Set the Time on the Water Heater	Built-in Controller
1.	Turn on the 120 VAC power supply to the water heater.	
2.	Simultaneously Press and Hold the TIME & SETTING buttons on the front controller till the display begins to flash.	 
3.	Use the UP or DOWN arrows to set to the current hour.	 
4.	Press the SETTING button to confirm and switch to minutes.	
5.	Use the UP or DOWN arrows to set the current minute.	 
6.	Press the SETTING button to confirm.	
7.	Simultaneously Press and Hold the TIME & SETTING buttons on the front controller to exit this mode.	 











Setting Recirculation Mode and Recirculation Type

Table 10: Recirculation Mode Settings

	Activating the Recirculation Modes & Setting the Aquastatic Parameters	Built-in Controller
1	Press and hold the SETTING button to enter A mode.	
2	Press the UP arrow to mode A05.	
3	Press the SETTING button. The display will flash the current stored setting.	
4	Press the UP arrow to display 1.	
5	Press the SETTING button to save the setting. The display then will alternate between the mode number and setting.	
6	<p>Press the UP arrow to display A06 and/or A07 based on the recirculation mode and activation/deactivation modes:</p> <p>a. Set A06 to:</p> <ul style="list-style-type: none"> Press SETTING, then press UP or DOWN to select the desired mode. <ul style="list-style-type: none"> 0 for Recirculation with a Return Line. 1 for Recirculation with a Crossover Valve. Press SETTING to save the selection. <p>b. Set A07 to:</p> <ul style="list-style-type: none"> Press the UP arrow to display A07 Press SETTING, then press UP or DOWN to select the desired mode. <ul style="list-style-type: none"> 0 to activate the pump with the Pump Timers. Go to step 7. 1 to activate the pump with the On-Demand Push Button. Press SETTING to save the selection. Go to step 19. 	
	Steps 7-10 sets the standby time from the previous heater operation, in minutes, till the next pump activation.	
7	Press the DOWN button to go to mode A02.	
8	Press the SETTING button to change the time delay setting. Refer to "Table 6: A-Mode Settings" on page 12 for available times.	







OPERATION

OPERATION

9	Press the UP or DOWN button to scroll to the desired time delay.	
10	<p>Press the SETTING button to save the setting.</p> <p>Go to the next step if the setting in A06 is 0 (recirculation with a return line). Go to step 19 if the setting in A06 is 1 (crossover valve recirculation).</p>	
	<p>Steps 11-18 sets the inlet water temperatures to activate/deactivate the pump. These values are subtracted from the water heater's set temperature.</p> <p>For example, with the default A03/A04 settings and set temperature of 120°F (49°C), the pump will activate when the inlet water temperature goes below 100°F (38°C) and deactivate when the inlet water temperature goes above 110°F (43°C).</p>	
11	Press the UP button to go to mode A03.	
12	Press the SETTING button. The display will alternate between the mode number and the current setting.	
13	Press the UP or DOWN button to select the desired setting. Refer to Table 6 on page 12 for available settings..	
14	Press the SETTING button to save the setting.	
15	Press the UP button to go to mode A04.	
16	Press the SETTING button. The display will alternate between the mode number and the current setting.	
17	Press the UP or DOWN button to select the desired setting. Refer to Table 6 on page 12 for available settings.	
18	Press the SETTING button to save the setting.	
19	Press and hold the SETTING button to exit the A mode. The display will return to the set temperature.	

Setting the Pump Timers

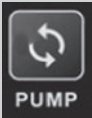
Table 11: Setting the pump timers





	Setting the Pump Timers	Built-in Controller
1	Press and hold the TIME button. The display will flash the hour value for Pump Timer 1. The Pump Timer 1 symbol and ON will be displayed.	
2	Press the UP or DOWN arrow to change the hour to the desired activation time.	
3	Press the SETTING button to save the setting and adjust the minute.	
4	Press the UP or DOWN arrow to adjust minute. The ON setting for Pump Timer 1 should now be set.	
5	Press the SETTING button to save the setting.	
6	Press the PUMP button to switch to the OFF time for Pump Timer 1. The Pump Timer 1 symbol and OFF will be displayed below the time. Repeat steps 2-5 to set the off time for Pump Timer 1.	
7	Press the TIME button to switch to Pump Timer 2 and repeat steps 2-5 to set the ON and OFF times.	
8	Press and hold the TIME button to exit.	

OPERATION

OPERATION

Pump Timer Activation

Table 12: Pump Timer Activation

	Activating the Pump Timers	Built-in Controller
1	Display must be showing the set temperature.	
2	Press and release the TIME button. The Pump Timer 1 LED will display after approximately 1 second. This will indicate that Pump Timer 1 is activated	
3	Press and release the TIME button to activate only Pump Timer 2.	
4	Press and release the TIME button to activate both Pump Timers.	
5	Press and release the TIME button to turn off both Pump Timers.	

Ignitor Rod

There two ignitor rod configurations, the primary difference is shown below in Figure 3. The units will be transitioning to Configuration B. The insulator on Configuration B is slightly larger. All other dimensions are the same. Configuration B can be installed without any modification to the water heater.

The gap between the return (rod) and spark (rod) is .18 in (4.5mm). If an adjustment is need use care not to damage or break the rods.

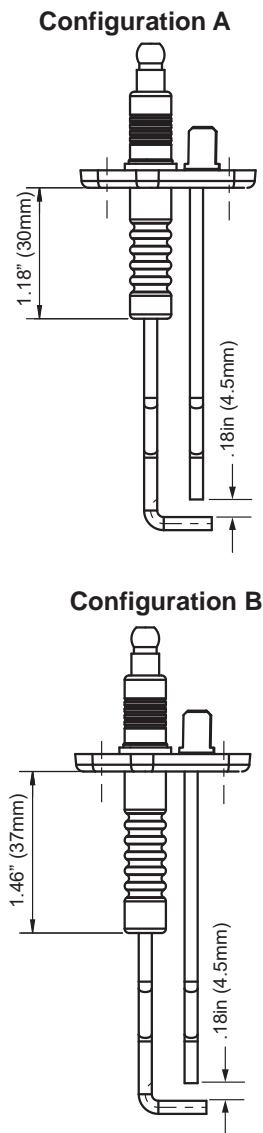

Figure 3: Ignitor rod configurations

Pressure Switch

The pressure switch uses a normally closed diaphragm that activates at 6.03 in WC \pm 0.15. The fault code is E421. With the water heater disconnect from electrical power, disconnect the red and black wires from the pressure switch. Use a multimeter to confirm continuity. If continuity is not present replace the pressure switch. See "Pressure Switch Replacement Kit Instructions" on page 59. Also reference "WIRING DIAGRAM" on page 130.

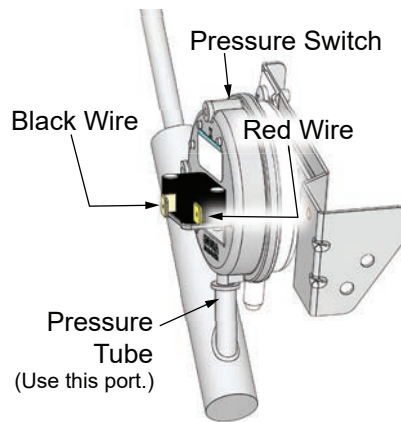

Figure 4 - Pressure Switch (exhaust)

Hi-Limit Switch (Manual)

The Hi-Limit switch (manual) can be manually reset by depressing the button in the center of the switch. This switch activates at 217°F (103°C). It will flash an E002 error code.

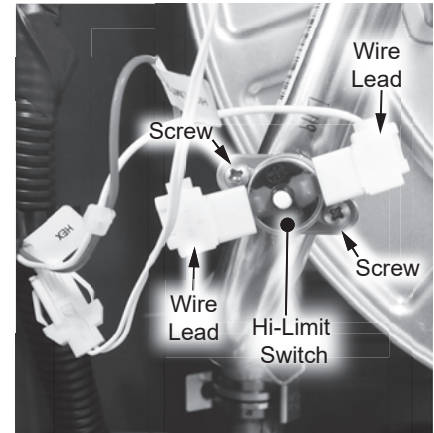

Figure 5 - Hi-Limit Switch (Manual)

Hi-Limit Switch (Burner Door)

The Hi-Limit switch (burner door) is a one time use switch and activates at 428°F (220°C). It will flash an E002 error code. This is the same code as the manual hi-limit switch.

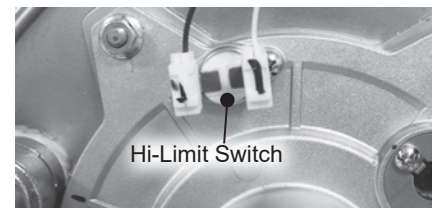

Figure 6 - Hi-Limit Switch (Burner Door)

COMPONENT DATA

Gas Valve (SIT)

The gas valve is a SIT model 848.

Gas Type(s)	NG, LP
Max Inlet Pressure	1/2 PSI (14"WC)
Ambient Temperature Range	14 to 140°F (-10 to 60°C)
Supply Voltage	120 VAC - 60Hz

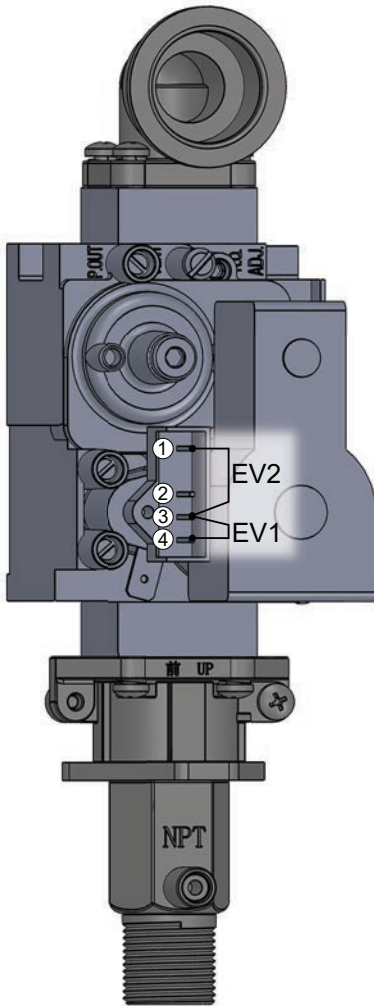

Figure 7 - Gas Valve (SIT)

See "Gas Valve Replacement Kit Instructions" on page 65 for replacement instructions.

Checking Gas Valve Voltage

Confirm 120 VAC on EV1 measured across pins three and four. Confirm 120 VAC on EV2 measured across pins one and three. See Figure 7.

Recirculation Pump

If the recirculation pump is making excessive noise use the following procedures to reduce it.

The PCB will modulate the power to the pump to target the following flow rates, based on pump mode:

Dedicated Return Pipe	1.05 gpm (4 lpm)
Crossover Valve	0.55 gpm (2.1 lpm)

By default, the max power the pump will operate up to in order to achieve the target flow rate is 60%. For instances of higher than expected resistance in the piping, the upper power limit can be adjusted up to 90% by going into the C18 mode.

1. Press and hold the "UP" button and the "SETTING" button for 5 seconds to access C Mode. The display will begin to flash.
2. Press the "UP" button or the "DOWN" button to access C18.
3. When at C18 press the "SETTING" button. Use the "UP" button or the "DOWN" button to set the value. The default setting is 60.
4. Press the "SETTING" button again to confirm the new value selected is correct.
5. Press and hold the "UP" button and the "DOWN" button for 5 seconds to return the display to normal operation. The display will stop flashing.

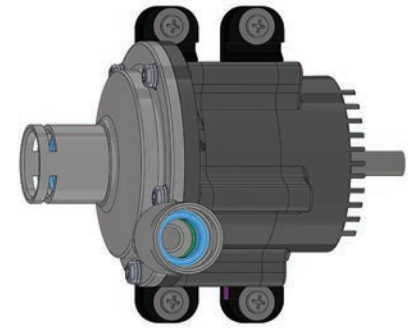

Figure 8 - Recirculation Pump

Propane Gas Conversion Diaphragm

If water heater has been converted to Propane and has water temperature fluctuations. This issue can occur if the Propane gas conversion diaphragm is wrinkled during the conversion. The following figures are examples of correct and incorrect diaphragms.



CORRECT:
The aluminum pillar and the diaphragm are centered. No wrinkle is present in the diaphragm.

Figure 9 - Correct diaphragm alignment



INCORRECT:
The aluminum pillar is in the middle, and the diaphragm is also offset from the center. Note the wrinkle in the diaphragm.

Figure 10 - Incorrect Aluminum pillar and diaphragm alignment.



INCORRECT:
Both the aluminum pillar and the diaphragm are off set from the center. Note the wrinkle in the diaphragm.

Figure 11 - Both the aluminum pillar and diaphragm are offset from the center.

The following figure shows the proper and improper methods to handle the diaphragm.



Figure 12 - Proper handling of the diaphragm.

Follow the Tankless Gas Conversion Instructions included with the water heater to access the diaphragm assembly. Correct any issues immediately. Reference Figure 9 through Figure 11.

COMPONENT DATA

Cascade System

Installation and Configuration

The Cascade System allows up to 12 heaters of the same input model to be linked electronically for various flow rate demands.

The Installation Instructions and Use & Care Guide provides the correct procedures for installing and configuring the Cascade System.

One heater MUST be set as the Parent water heater. The Parent water heater will instruct the Child water heaters in the Cascade System to activate and deactivate as necessary.

Mode C13 sets the Parent water heater by identifying the number of Child water heaters in the Cascade System.

Mode C14 identifies the water heater number in the system. The Parent heater will always have a value of 1. The Child water heaters will have a value of 2 up to 12. See Figure 13 below for an example of a typical Cascade System and how it is configured.

Priority Order Determination

The heaters will rotate the Priority water heater (first to activate) on a weekly basis. The Priority water heater will be set based on the water heater with the least combustion time. The second water heater will be set based on the water heater with the second least combustion time, and so on for the remaining water heaters in the Cascade System. The combustion time for each water heater can be viewed in mode

P20. See Table 8 on page 14 for information on accessing P mode.

Activation and Deactivation Logic

Water heaters in the Cascade System will activate and deactivate based on the water temperature rise of the Priority water heater. Table 15 - Table 18 list the activation and deactivation of the model based on the Priority water heater's temperature rise (ΔT):

$$\Delta T = T_{set} - T_{in}$$

T_{set} = Set Temperature
 T_{in} = Inlet Temperature

The tables show the system flow rate when the next water heater will activate and likewise deactivate.

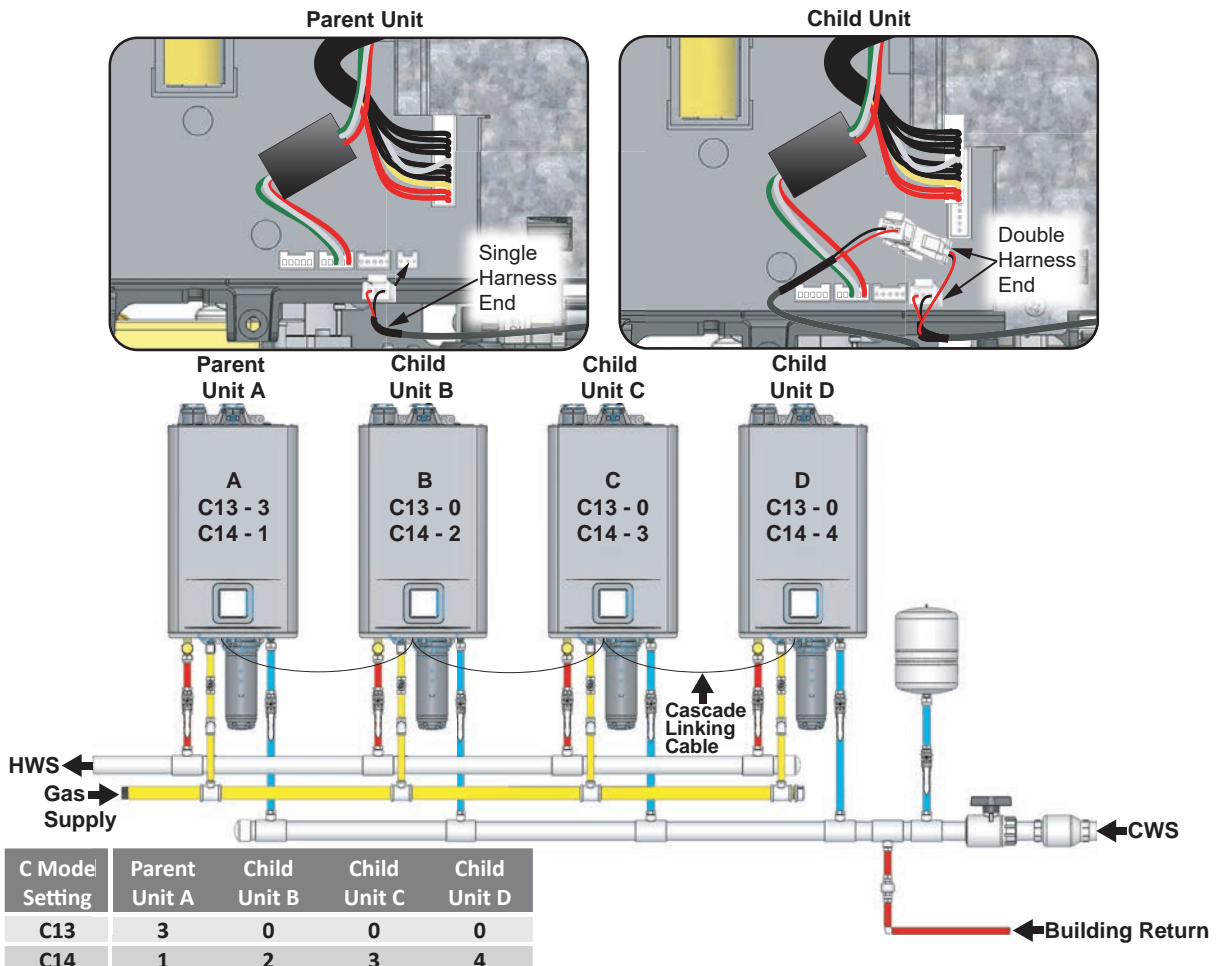

Figure 13 - Cascade System Installation & Configuration

Testing a Cascade System

Verify the system is installed as shown in the water heater's Installation Instruction Use and Care & Guide. The water piping must be installed in a "Reverse-Return" format to promote equal "path of resistance" through each water heater in the Cascade System.

IMPORTANT: Unequal paths of resistance will cause some water heaters to operate more frequently than other units in the Cascade System, and can lead to fluctuation of outlet water temperatures.

If the issue is an error code, check for the following:

See page 30 for more information on how error codes will display in a Cascade System.

1. Verify the heaters are set properly in the C13 & C14 modes.
 - Press and hold the "UP" button and the "SETTING" button for 5 seconds to access C Mode.
 - Press the "UP" button or the "DOWN" button to search for the desired C Code.
 - Press and hold the "UP" button and the "SETTING" button for 5 seconds to return the display to normal operation.
2. Test the water heater(s) with an error code as an individual unit, removing it from the Cascade System. Do this by changing mode C14 to 0.

NOTICE: Record the original value of C14 before changing to 0. This value will need to be reentered once the error code has been resolved.

 - Press and hold the "UP" button and the "SETTING" button for 5 seconds to access C Mode.

- Press the "UP" button or the "DOWN" button to search for the desired C Code.
- If applicable, press the "SETTING" button to adjust the value of the C Code using the "UP" and "DOWN" buttons. The value will flash.
- Press the "SETTING" button again to confirm the new value selected is correct.
- Press and hold the "UP" button and the "SETTING" button for 5 seconds to return the display to normal operation.

NOTICE: If the problem water heater is the Parent unit, you will need to set the next water heater in line as the new Parent unit.

3. Disconnect the cascade wiring from the water heater. Cycle the power of the heater off, then on. **DO NOT** use the **ON/OFF** button on the user interface module.
 - Before proceeding, determine if isolation valves are installed. If so, close the outlet valve and hook up a hose to the isolation valve port. Run the hose to a drain or outside in order to operate the water heater as an individual water heater.
 - If isolation valves are not installed, you will have to test the water heater while the overall system is not in use.
4. Refer to the "Fault Analysis of Error Codes" section on page 30 for error code information.
5. Once the error code is resolved, reattach the cascade wire to the water heater's PCB. Return to mode C14 and set the display to the previous value recorded in Step 2.

If the issue is water temperature fluctuations, check for the following:

- Verify the plumbing is reverse return.
- Verify the outlet water temperature of each active water heater via the P01 mode.
- Verify the flow rate through each active water heater via the P03 mode. A reduced flow rate by one heater may indicate a clogged inlet filter, insufficient gas supply, too large gas pressure drop, blocked exhaust and/or intake, etc.
- Verify the C mode settings are accurate for the installation.
- If a recirculation system is set up, verify the check valve on the return line prior to the inlet water tee is operating correctly. An improperly operating check valve can reduce the recirculation pump's flow rate causing temperature fluctuations.

COMPONENT DATA

Table 15: Activation ΔT and Flow Rates

Activation: Altitude 0 – 5,399 ft. (C0=0,1)									
ΔT # of Units	THR-160 (gpm)			THR-180 (gpm)			THR-199 (gpm)		
	< 60°F	60°F - 80°F	> 80°F	< 60°F	60°F - 80°F	> 80°F	< 60°F	60°F - 80°F	> 80°F
1 to 2	4.9	3.5	2.7	5.5	3.9	3.1	6.1	4.3	3.4
2 to 3	9.8	7	5.4	11	7.8	6.2	12.2	8.6	6.8
3 to 4	14.7	10.5	8.1	16.5	11.7	9.3	18.3	12.9	10.2
4 to 5	19.6	14	10.8	22	15.6	12.4	24.4	17.2	13.6
5 to 6	24.5	17.5	13.5	27.5	19.5	15.5	30.5	21.5	17
6 to 7	29.4	21	16.2	33	23.4	18.6	36.6	25.8	20.4
7 to 8	34.3	24.5	18.9	38.5	27.3	21.7	42.7	30.1	23.8
8 to 9	39.2	28	21.6	44	31.2	24.8	48.8	34.4	27.2
9 to 10	44.1	31.5	24.3	49.5	35.1	27.9	54.9	38.7	30.6
10 to 11	49	35	27	55	39	31	61	43	34
11 to 12	53.9	38.5	29.7	60.5	42.9	34.1	67.1	47.3	37.4

Table 16: Deactivation ΔT and Flow Rates

Deactivation: Altitude 0 – 5,399 ft. (C0=0,1)									
ΔT # of Units	THR-160 (gpm)			THR-180 (gpm)			THR-199 (gpm)		
	< 60°F	60°F - 80°F	> 80°F	< 60°F	60°F - 80°F	> 80°F	< 60°F	60°F - 80°F	> 80°F
12 to 11	43	30.8	24.1	48.4	34.2	27.4	53.8	37.5	29.8
11 to 10	39.1	28	21.9	44	31.1	24.9	48.9	34.1	27.1
10 to 9	35.2	25.2	19.7	39.6	28	22.4	44	30.7	24.4
9 to 8	31.3	22.4	17.5	35.2	24.9	19.9	39.1	27.3	21.7
8 to 7	27.4	19.6	15.3	30.8	21.8	17.4	34.2	23.9	19
7 to 6	23.5	16.8	13.1	26.4	18.7	14.9	29.3	20.5	16.3
6 to 5	19.6	14	10.9	22	15.6	12.4	24.4	17.1	13.6
5 to 4	15.7	11.2	8.7	17.6	12.5	9.9	19.5	13.7	10.9
4 to 3	11.8	8.4	6.5	13.2	9.4	7.4	14.6	10.3	8.2
3 to 2	7.8	5.6	4.3	8.8	6.2	5	9.8	6.9	5.4
2 to 1	3.9	2.8	2.2	4.4	3.1	2.5	4.9	3.4	2.7

COMPONENT DATA

COMPONENT DATA

Table 17: Activation ΔT and Flow Rates

Activation: Altitude 5,399 - 10,000 ft. (C0=0,1)									
ΔT # of Units	THR-160 (gpm)			THR-180 (gpm)			THR-199 (gpm)		
	< 60°F	60°F - 80°F	> 80°F	< 60°F	60°F - 80°F	> 80°F	< 60°F	60°F - 80°F	> 80°F
1 to 2	3.1	2.2	1.7	3.4	2.4	1.9	3.8	2.7	2.1
2 to 3	6.1	4.4	3.4	6.9	4.9	3.9	7.6	5.4	4.3
3 to 4	9.2	6.6	5.1	10.3	7.3	5.8	11.4	8.1	6.4
4 to 5	12.3	8.8	6.8	13.8	9.8	7.8	15.3	10.8	8.5
5 to 6	15.3	10.9	8.4	17.2	12.2	9.7	19.1	13.4	10.6
6 to 7	18.4	13.1	10.1	20.6	14.6	11.6	22.9	16.1	12.8
7 to 8	21.4	15.3	11.8	24.1	17.1	13.6	26.7	18.8	14.9
8 to 9	24.5	17.5	13.5	27.5	19.5	15.5	30.5	21.5	17.0
9 to 10	27.6	19.7	15.2	30.9	21.9	17.4	34.3	24.2	19.1
10 to 11	30.6	21.9	16.9	34.4	24.4	19.4	38.1	26.9	21.3
11 to 12	33.7	24.1	18.6	37.8	26.8	21.3	41.9	29.6	23.4

Table 18: Deactivation ΔT and Flow Rates

Deactivation: Altitude 5,399 - 10,000 ft. (C0=0,1)									
ΔT # of Units	THR-160 (gpm)			THR-180 (gpm)			THR-199 (gpm)		
	< 60°F	60°F - 80°F	> 80°F	< 60°F	60°F - 80°F	> 80°F	< 60°F	60°F - 80°F	> 80°F
12 to 11	26.9	19.3	15.1	30.3	21.4	17.1	33.6	23.4	18.6
11 to 10	24.4	17.5	13.7	27.5	19.4	15.6	30.6	21.3	16.9
10 to 9	22.0	15.8	12.3	24.8	17.5	14.0	27.5	19.2	15.3
9 to 8	19.6	14.0	10.9	22.0	15.6	12.4	24.4	17.1	13.6
8 to 7	17.1	12.3	9.6	19.3	13.6	10.9	21.4	14.9	11.9
7 to 6	14.7	10.5	8.2	16.5	11.7	9.3	18.3	12.8	10.2
6 to 5	12.3	8.8	6.8	13.8	9.8	7.8	15.3	10.7	8.5
5 to 4	9.8	7.0	5.4	11.0	7.8	6.2	12.2	8.6	6.8
4 to 3	7.4	5.3	4.1	8.3	5.9	4.6	9.1	6.4	5.1
3 to 2	4.9	3.3	2.7	5.5	3.9	3.1	6.1	4.3	3.4
2 to 1	2.4	1.8	1.4	2.8	1.9	1.6	3.1	2.1	1.7

COMPONENT DATA

TROUBLESHOOTING

General Troubleshooting

Table 19: Troubleshooting Chart

	PROBLEM	SOLUTIONS
Temperature and Amount of Hot Water	It takes a long time to get hot water at the fixtures.	<ul style="list-style-type: none"> The time it takes to deliver hot water from the water heater to your fixtures depends on the length of piping between the two. The longer the distance or the bigger the pipes, the longer it will take to get hot water. If using the recirculation pump, check the settings to verify the Pump Timers are active.
	The water is not hot enough.	<ul style="list-style-type: none"> Check the set temperature of the water heater and adjust, if necessary. Check cross plumbing between the cold water lines and hot water lines. Is the gas supply valve open fully? Is the gas line sized properly? Is the gas supply pressure sufficient? Check if the Point-of-Use mixing valves are set correctly, if they are installed.
	The water is too hot.	<ul style="list-style-type: none"> Is the set temperature set too high?
	The hot water is not available when a fixture is opened.	<ul style="list-style-type: none"> Make sure the unit has 120 VAC, 60 Hz power supply and power frequency is set to 60 hz. Verify the operation setting is ON by viewing the UIM. If the set temperature is showing or you press the UP arrow to display the set temperature, then the operation setting is ON. If the display is blank and nothing appears when pressing the UP button, then the operation state is set to OFF. Press the ON/OFF button to activate the heater. The set temperature will display when set to ON. Is the gas supply valve open fully and within the allowable gas pressure range? Is the water supply valve open fully? Is the filter on the cold water inlet clean? Is the hot water fixture sufficiently open to draw at least 0.4 GPM (1.5 L/min) through the water heater? Is the unit frozen? Is there enough gas in the tank / cylinder? (For Propane models)
	The hot water turns cold and stays cold.	<ul style="list-style-type: none"> Is the flow rate enough to keep the water heater running? If there is a recirculation system installed, does the recirculation line have enough check valves? Is the gas supply valve open fully? Is the filter on the cold water inlet clean? Are the fixtures clean of debris and obstructions?
	Fluctuation in hot water temperature.	<ul style="list-style-type: none"> Is the filter on the cold water inlet clean? Is the gas line sized properly? Is the supply gas pressure sufficient? Check for cross connection between the cold water lines and hot water lines. If converted to propane, verify the propane diaphragm assembly is installed correctly. Reference the Propane conversion instructions. Inspect and verify the rubber diaphragm on the assembly is not distorted If cascaded with multiple heaters, inspect and verify each heater is operating properly within the cascade system.

TROUBLESHOOTING

	PROBLEM	SOLUTIONS
WATER HEATER	Unit does not ignite when water goes through the unit.	<ul style="list-style-type: none"> • Is the flow rate over 0.4 GPM (1.5 L/min)? • Check for the filter on the cold water inlet. • Check for reverse connection and cross connection. • If you use the remote controller and/or built-in controller, is the power button turned on? • Check if the inlet temperature is too high. If it is too close to the set temperature, the water heater will not activate.
	The fan motor is still spinning after operation has stopped.	<ul style="list-style-type: none"> • This is normal. After operation has stopped, the fan motor keeps running in order to re-ignite quickly, as well as to purge all the exhaust gas out of the flue.
	Unit sounds abnormal while in operation	<ul style="list-style-type: none"> • Check all venting and terminations for any blockage and clear. • If other exhaust terminations are nearby, confirm flue gases are not sucked into the water heater's air intake. • Contact Technical Support Department.

TROUBLESHOOTING

Error Codes

The water heater has self-diagnostic functions for safety and convenience when troubleshooting.

If there is a problem with the installation or the unit, the error code associated with that failure will be displayed on the built-in controller or remote controller. The display will flash E and the three digit number. It will show leading zeros. Example: E002

Error codes in the cascade system are different. The heater number and E### (three digit number) will alternately flash on the parent unit's user interface module (UIM) and temperature remote controller. The child unit in error will flash the E### (three digit number) on its UIM.

Consult the the tables below for the description of each error code.

Fault Analysis of Error Codes

If the water heater is displaying an error code, please check the following. After checking, consult with the manufacturer.

Table 20: Error Code Fault Analysis

Error Code	Error Type	Procedure
E002	Hi-Limit Switches	<ol style="list-style-type: none"> 1. Visual inspection: connection/breakage of wires. Possibility also includes scale deposits inside the heat exchanger if using an M model. 2. Manual Hi-Limit Switch on water outlet tripped. Check the switch for proper operation. Press the reset button (center of the switch), to reset it. NOTE: You will hear and feel the switch click when resetting it. If the hi-limit switch continues to trip replace the hi-limit switch. 3. Automatic Hi-Limit Switch on burner door tripped. If the automatic Hi-limit switch trip has occurred, it cannot be reset and must be replaced. 4. Visual inspection: connection/breakage of wires. 5. M Model: If water heater is installed in a hard water area the manual hi-limit switch may trip due to scaling.
E006	PCB Hardware Fault	<ol style="list-style-type: none"> 1. Check PCB wiring for loose, damaged, or cut wires/connectors. Correct any loose connections and replace any damaged wires/connectors. If all wires/connectors are intact, replace the PCB.
E010	Frequency Fault	<ol style="list-style-type: none"> 1. PCB has detected an incorrect power supply frequency. Note the default frequency is 60 Hz. Confirm that C07 is set to the correct frequency of the supply power. See Table 7 to access modes. if C07=60 48<X<72 if C07=50 40<X<60 2. If the setting is correct and the error still occurs, check supply to confirm frequency range.
E011	PCB - Memory	<ol style="list-style-type: none"> 1. The water heater will continue to operate while in this error code is flashing, however, the recirculation pump will be disabled. If this heater is part of a cascade system, then the system will be affected based on the heater's setting. PCB must be replaced on impacted heater. <ul style="list-style-type: none"> • Parent Heater: The cascade system will not operate. Remove this heater from the cascade system and set a different heater as the Parent. • Child Heater: This heater will not operate. The rest of the cascade system will continue to run.

TROUBLESHOOTING

Error Code	Error Type	Procedure
E036	Flame Failure	<p>WARNING! Working on an energized circuit can result in severe injury or death from electrical shock.</p> <ol style="list-style-type: none"> 1. Verify that the gas supply pressure is within specifications when the heater is in standby, and verify the gas pressure does not drop below the minimum specified supply pressure when all gas appliances are in operation. Also, verify that the gas line is cleared of debris. For Propane installations, verify the propane tank level is not too low. <ul style="list-style-type: none"> • It is possible that there is a faulty pressure regulator at the gas meter. • If a second stage regulator is installed, verify the following: that it is sized properly for the application; that it is installed per the manufacturer's instruction (pay close attention if an indoor vent limiter is installed); the vent line (if installed) is sized properly. Note: Some manufacturers may recommend that a specific amount of straight pipe is installed on the regulator outlet before any changes in direction. Refer to the regulator's manufacturer. 2. Check for blockages in venting, such as bird nests, animals, or trash. A blockage will cause improper operation leading to reduced capacity and inability to maintain combustion. 3. If flame ignites for only 1-2 seconds before going out, verify that the red Flame Detected flame indicator on the built-in controller or remote controller did not turn on. If the flame indicator stayed off, then inspect the flame sensor. Clean it if necessary. Replace it if any damage is seen.
E037	False Flame Detection (During Standby)	<p>WARNING! Working on an energized circuit can result in severe injury or death from electrical shock.</p> <ol style="list-style-type: none"> 1. Verify the gas supply pressure is not above the specified maximum pressure. If it is, troubleshoot and correct the gas supply system. 2. Check the error code history, P modes P12, P13, P14 and document the codes. <ul style="list-style-type: none"> • If E384 is in the list, replace the gas valve. • If E412 or E414 appear, replace the PCB. • If E413 or E417 appear, inspect the flame sensor rod for dirt, debris, or damage. Clean or replace the flame sensor. If either code appears again, replace the PCB. Note: You must run water through the heater for a minimum of 3 minutes at a minimum of 1 gpm to check for E417.

TROUBLESHOOTING

Error Code	Error Type	Procedure
E038	Ignition Failure	<p>WARNING! Working on an energized circuit can result in severe injury or death from electrical shock.</p> <ol style="list-style-type: none"> Verify that the gas supply pressure is within specifications when the heater is in standby, and verify the gas pressure does not drop below the minimum specified supply pressure when all gas appliances are in operation. Also, verify that the gas line is cleared of debris. For Propane installations, verify the propane tank level is not too low. <ul style="list-style-type: none"> It is possible that there is a faulty pressure regulator at the gas meter. If a second stage regulator is installed, verify the following: that it is sized properly for the application; that it is installed per the manufacturers instruction (pay close attention if an indoor vent limiter is installed); the vent line (if installed) is sized properly. Note: Some manufacturer's may recommend that a specific amount of straight pipe is installed on the regulator outlet before any changes in direction. Refer to the regulator's manufacturer. Check for blockages in venting, such as bird nests, animals, or trash. A blockage will cause improper operation leading reduced capacity and inability to maintain combustion. If flame ignites for only 1-2 seconds before going out, verify that the red Flame Detected flame indicator on the built-in controller or remote controller did not turn on. If the flame indicator stayed off, then inspect the flame sensor. Clean it if necessary. Replace it if any damage is seen. Verify the gap on the ignitor rods is within specs. Refer to page 21. Replace the ignitor rod if the gap is out of tolerance.
E041	Outlet Water Over-temp.	<ol style="list-style-type: none"> Verify the thermistor reading with the water outlet temperature. See "THERMISTOR RESISTANCE VS TEMPERATURE CHARTS" on page 131. Remove the outlet thermistor (do not lose the o-ring) and check for any dirt or debris. Clean with an Emery cloth. If the thermistor is damaged, replace it. Check all venting for any blockage and clear. Verify gas pressure and supply and if failure persists replace gas valve.
E045	Clock Battery Replacement	<ol style="list-style-type: none"> The clock battery voltage is low indicating it should be replaced with a 2032 type battery. This error may also appear when supply power has been turned back on. In this case, ignore the error code. Reference "Printed Circuit Board Battery" on page 40 in the installation manual. Note: The battery has a plastic cover, remove before installation.
E049	Exhaust Thermistor Failure	<ol style="list-style-type: none"> Remove the thermistor (do not lose the o-ring) and check for any dirt or debris. Clean with an Emery cloth. If the thermistor is damaged, replace it. Check the Thermistor sensor wire for a short or disconnection. Correct any loose connections and replace any damaged wire/connector or thermistor assembly. Check all venting (intake/exhaust) for an blockages and clear as necessary. Verify gas pressure and supply and if failure persists replace gas valve.
E050	Inlet Thermistor Failure	<ol style="list-style-type: none"> Remove the thermistor (do not lose the o-ring) and check for any dirt or debris. Clean with an Emery cloth. If the thermistor is damaged, replace it. Check the Thermistor sensor wire for a short or disconnection. Correct any loose connections and replace any damaged wire/connector.

TROUBLESHOOTING

Error Code	Error Type	Procedure
E051	Outlet Thermistor Failure	<ol style="list-style-type: none"> 1. Remove the thermistor (do not lose the o-ring) and check for any dirt or debris clean with Emery cloth. If the thermistor is damaged, replace it. 2. Check the Thermistor sensor wire for a short or disconnection. Correct any loose connections and replace any damaged wire/connector.
E052	Heat Exchanger Thermistor Failure	<ol style="list-style-type: none"> 1. Remove the thermistor (do not lose the o-ring) and check for any dirt or debris clean with Emery cloth. If the thermistor is damaged, replace it. 2. Check the Thermistor sensor wire for a short or disconnection. Correct any loose connections and replace any damaged wire/connector. 3. Check all venting (intake/exhaust) for an blockages and clear as necessary. Verify gas pressure and supply and if failure persists replace gas valve.
E383	Inlet Water Over-Temp.	<ol style="list-style-type: none"> 1. Verify the inlet water temperature is not above the water heater's set temperature. 2. Remove the inlet thermistor (do not lose the o-ring) and check for any dirt or debris. Clean with Emery cloth. If the thermistor is damaged, replace it. 3. Check the Thermistor sensor wire for a short or disconnection. Correct any loose connections and replace any damaged wire/connector. 4. If error persists replace it.
E384	False Flame Detection (During Shutdown)	<p>WARNING! Working on an energized circuit can result in severe injury or death from electrical shock.</p> <ol style="list-style-type: none"> 1. Look through the sight glass for a flame. If the flame is present, immediately shut off the gas to the water heater. 2. If no flame is present and the flame LED on the display is lit, Check the flame sensor wire for a short or disconnection. Correct any loose connections and replace any damaged wire/connector. 3. Inspect and clean the flame sensor 4. Check gas supply pressure is within approved limits. 5. Check gas valve and replace if necessary. See "Gas Valve Replacement Kit Instructions" on page 65.
E385	Gas Valve - SV1	<ol style="list-style-type: none"> 1. The PCB detects an incorrect voltage from the gas valve solenoid valve 1 (EV1). Correct any loose connections and replace any damaged wire/connector. Voltage across the EV1 wires should measure 120 volts. See "Checking Gas Valve Voltage" on page 22. 2. If the voltage does not measure 120 volts, replace the gas valve.
E388	Bypass Valve	<ol style="list-style-type: none"> 1. Correct any loose connections and replace any damaged wire/connector. 2. Follow the draining procedure in the installation manual to properly drain the water heater. Remove the Bypass valve and inspect for any debris or damage. Replace if needed.
E392	Fan - False Start	<ol style="list-style-type: none"> 1. Check the fan motor wiring. Correct any loose connections and replace any damaged wire/connector.

TROUBLESHOOTING

TROUBLESHOOTING

Error Code	Error Type	Procedure
E393	Fan - Signal Loss	<ol style="list-style-type: none"> 1. Check the fan motor wiring. Correct any loose connections and replace any damaged wire/connector.
E394	Fan - Target Speed	<ol style="list-style-type: none"> 1. Check the fan motor wiring. Correct any loose connections and replace any damaged wire/connector. 2. With the water heater power disconnected, check the exhaust vent and air intake piping for any blockages. Remove any blockages.
E396	Pump - Low Speed	<ol style="list-style-type: none"> 1. Check the pump wiring for a short or disconnection. Correct any loose connections and replace any damaged wire/connector. 2. Check the inlet filter for debris and clean. 3. Check the pump and water lines for debris and clear. 4. Check for a faulty check valve or something else creating resistance and clear. 5. Check the plumbing system for a cross connection. Eliminate if one exists. 6. Check to ensure the maximum pipe length and size has not been exceeded and meets the requirements in the Recirculation and Combination Potable Water sections of the installation manual. 7. If error persists after above troubleshooting replace pump.
E397	Pump - Low Current	<ol style="list-style-type: none"> 1. Inspect the plumbing system for additional resistance such as trapped air bubbles, a faulty or missing check valve, and a cross connection. 2. If error persists after above troubleshooting replace pump.
E398	Pump - Low Water Flow	<ol style="list-style-type: none"> 1. Check the pump wiring for a short or disconnection. Correct any loose connections and replace any damaged wire/connector. 2. Check the inlet filter for debris and clean. 3. Check the pump and water lines for debris and clear. 4. Check for a check valve stuck in the closed position; a shutoff valve in the closed position; or something else creating resistance. Clear the blockage. 5. Check to ensure the maximum pipe length and size has not been exceeded and meets the requirements in the Recirculation and Combination Potable Water sections of the installation manual. 6. If error persists after above troubleshooting replace pump.
E399	Pump - Power Limit Exceeded	<ol style="list-style-type: none"> 1. Check the pump wiring for a short or disconnection. Correct any loose connections and replace any damaged wire/connector. 2. If error persists after above troubleshooting replace pump.
E400	Communication Fault with UIM	<ol style="list-style-type: none"> 1. Check the UIM wiring. Correct any loose connections and replace any damaged wire/connector. 2. If UIM is displaying replace the PCB. If UIM is not displaying, replace the UIM.

TROUBLESHOOTING

Error Code	Error Type	Procedure
E401	Communication Fault with Remote Controller	<ol style="list-style-type: none"> 1. Check the Remote Controller wiring. Correct any loose connections and replace any damaged wire/connector. 2. Only one remote controller can be installed, remove any additional remote controllers. 3. If the error still occurs, and remote is displaying values then replace the PCB.
E402	Communication Fault in Cascade System	<ol style="list-style-type: none"> 1. Check the Cascade wiring. Correct any loose connections and replace any damaged wire/connector. 2. Cycle the child heater's power off/on if the cascade wiring was disconnected while the system still had power. 3. If the error still persists verify parent heater PCB functionality replace PCB if necessary.
E403	Fan - Low Speed	<ol style="list-style-type: none"> 1. Check the fan motor wiring. Correct any loose connections and replace any damaged wire/connector. 2. With the water heater power disconnected, check the exhaust vent and air intake piping for any blockages. Remove any blockages. 3. If the error still occurs, replace the fan.
E411	Heat Exchanger - Water Overheating	<ol style="list-style-type: none"> 1. Remove the heat exchanger thermistor (do not lose the o-ring) and check for any dirt or debris. Clean with an emery cloth. If the thermistor is damaged, replace it. 2. Check the Thermistor sensor wire for a short or disconnection. Correct any loose connections and replace any damaged wire/connector. 3. Check all venting (intake/exhaust) for an blockages and clear as necessary. Verify gas pressure and supply and if failure persists replace gas valve.
E412	PCB - Hardware	<ol style="list-style-type: none"> 1. Replace the PCB.
E413	Flame Sensor	<ol style="list-style-type: none"> 1. Check the flame sensor wire for a short or disconnection. Correct any loose connections and replace any damaged wire/connector. 2. With the water heater power disconnected, check the exhaust vent and air intake piping for any blockages. Remove any blockages. 3. Verify the water heater has sufficient combustion air, reference the Combustion and Venting Installation section in the installation manual. 4. Check the installation area for corrosive elements, reference the see Installation Environment section in the installation manual. 5. Remove and inspect the flame sensor, check for any dirt or debris clean with Emery cloth. If error persists replace flames sensor. 6. Is the heater properly grounded.
E414	PCB-Flame Sensor Circuit	<ol style="list-style-type: none"> 1. Check the flame sensor wire for a short or disconnection. Correct any loose connections and replace any damaged wire/connector. 2. If the error still occurs, replace the PCB.
E415	Gas Valve Fault	<ol style="list-style-type: none"> 1. Check the gas valve wiring for a short or disconnection. Correct any loose connections and replace any damaged wire/connector. 2. If the error still occurs, check power supply to gas valve.

TROUBLESHOOTING

Error Code	Error Type	Procedure
E416	Analog/Digital (A/D) Value Fault	<ol style="list-style-type: none"> 1. Check the outlet thermistor sensor wire for a short or disconnection. Correct any loose connections and replace any damaged wire/connector. 2. Remove the outlet thermistor (do not lose the o-ring) and check for any dirt or debris. Clean with an Emery cloth. If the thermistor is damaged, replace it. 3. If the error still occurs, replace the PCB.
E417	Flame Sensor Fault	<ol style="list-style-type: none"> 1. Check the flame sensor wire for a short or disconnection. Correct any loose connections and replace any damaged wire/connector. 2. Check the inlet & heat exchanger thermistor wires for a short or disconnection. Correct any loose connections and replace any damaged wires/connectors. 3. This code may appear after 3 minutes of operation if the heat exchanger thermistor reading did not increase over the inlet thermistor ready by at least 5.4°F (3°C). <ol style="list-style-type: none"> i. During standby, record the inlet & heat exchanger values via P modes P02 & P00, respectively. ii. Activate the water heater with at least 1 gpm flow rate. Monitor the heat exchanger thermistor reading, P00. iii. If the thermistors readings are abnormal, during standby w/ water drained from the heater, remove the thermistors and inspect for damage/dirt/debris. Replace thermistors if necessary. Install the thermistors and rerun this procedure to determine if there was improvement. iv. If the error code reappears and the thermistor readings were correct, replace the PCB.
E418	Exhaust High Temperature	<ol style="list-style-type: none"> 1. With the water heater power disconnected, check the exhaust vent and air intake piping for any blockages. Remove any blockages. 2. Remove the exhaust thermistor (do not lose the o-ring) and check for any dirt or debris clean with Emery cloth. If the thermistor is damaged, replace it. 3. Check all venting (intake/exhaust) for an blockages and clear as necessary. Verify gas pressure and supply and if failure persists replace gas valve.
E420	Gas Valve - SV2	<ol style="list-style-type: none"> 1. The PCB detects an incorrect voltage from the gas valve solenoid valve 2 (EV2). Correct any loose connections and replace any damaged wire/connector. Voltage across the EV2 wires should measure 120 volts. See "Checking Gas Valve Voltage" on page 22. 2. If the voltage does not measure 120 volts, replace the gas valve.
E421	Pressure Switch	<ol style="list-style-type: none"> 1. With the water heater power disconnected, check the exhaust vent and air intake piping for any blockages. Remove any blockages. The pressure switch will trip when the pressure in the exhaust vent is 5.88"wc or higher 2. Check the pressure tube for loose connections, debris, water, or blockages. Correct any issue immediately. 3. If the error still occurs, replace the pressure switch.

TROUBLESHOOTING

Error Code	Error Type	Procedure
E422	Venturi Assembly	<ol style="list-style-type: none"> 1. Check the venturi assembly wires for a short or disconnection. Correct any loose connections and replace any damaged wire/connection 2. Ensure intake air is free of dirt or debris. 3. If the error still occurs, replace venturi assembly.
E426	Condensate Drain Overflow	<ol style="list-style-type: none"> 1. Place a bucket under the water heater to catch any water. 2. With the water heater off, check the condensate drain for any blockages. Remove any blockages. 3. Check the condensate drain wires for a short or disconnection. Correct any loose connections and replace any damaged wire/connector. 4. Verify the condensate drain line is installed correctly, reference the installation manual.
E427	Flow Control Valve	<ol style="list-style-type: none"> 1. Check the flow control valve wires for a short or disconnection. Correct any loose connections and replace any damaged wire/connector. 2. Remove the flow control valve and inspect for any debris or damage. Replace if needed. First follow the Unit Draining & Power Outage section in the installation manual.
E428	Flow Sensor - Cascade Only	<ol style="list-style-type: none"> 1. Verify the water heater's operation is enabled. The heater's UIM will display the set temperature when enabled. If it is disabled, press the heater's ON/OFF button to enable the heater's operation. 2. Verify that the heater's water shutoff valves are open. 3. Check the flow sensor wires for a short or disconnection. Correct any loose connections and replace any damaged wire/connector. 4. Drain the water heater following the Unit Draining & Power Outage section in the installation manual. Remove the flow sensor and inspect for any debris or damage. Replace if needed. Remove and clean the inlet water filter.
E429	Flow Control Valve Fault - Cascade Only.	<ol style="list-style-type: none"> 1. Check the flow control valve wires for a short or disconnection. Correct any loose connections and replace any damaged wire/connector. 2. Remove the flow control valve and inspect for any debris or damage. Replace if needed. First follow the draining procedure in the Unit Draining & Power Outage section in installation manual.

TROUBLESHOOTING

Descaling

During operation, a tankless water heater (supplied with hard water) accumulates hard water deposits on the interior surfaces of the heat exchanger. These deposits make it difficult to transfer heat into the water, lowering the water heater's efficiency and causing excessive wear to the components. Removing any deposits is essential to the proper operation and longevity of the water heater. The X3 model should not require descaling, however, if you choose to descale the water heater **you must use the Bypass cartridge**. A Bypass cartridge can be ordered from the manufacturer, p/n: 100374700.

NOTICE: DO NOT descale the water heater using the X3 cartridge as this may damage the cartridge media. See your Installation Instructions and Use & Care Guide for instructions on how to remove the X3 and install the Bypass.

Tools and Materials:

- Submersible transfer pump
- 3 gallons of 5% acidity white vinegar (food grade), available from most grocery stores
- Washing machine hoses (2)
- Five gallon bucket
- Water heater isolation valve kits, installed on both the cold water inlet and hot water outlet of the water heater X3 Bypass Cartridge (See Figure 14)

The water heater has a descaling mode that will do the following to help descale the water heater:

- Locks out the heater firing operation so the heater remains in standby.
- The flow control valve will stay in the fully open position
- The bypass water valve will move to

the fully closed position to force the descaling solution through the heat exchanger.

- The internal recirculation pump will not activate, if it is set for use
 - The freeze protection system will not be active.
1. Close the isolation valves (C & D) to stop the main inlet/outlet flow of water to the house. See Figure 14.
 2. Pour the white vinegar (3 gallons) into the five gallon bucket. See Figure 15.
 3. Connect inlet hose to the transfer pump's discharge outlet. Connect its opposite end to the inlet hose connection at the cold water inlet's isolation valve. See Figure 15.
 4. Place the pump in the bucket of vinegar.
 5. Connect the second hose to the outlet hose connection at the hot water outlet. Place its loose end into the bucket with the vinegar. See Figure 15.
 6. Open the hot and cold service valves (A & B). See Figure 15.
 7. Activate the water heater's descaling mode by entering the C mode.
 - A. Simultaneously press and hold the UP arrow and Setting button for approximately 6 seconds.
 - A. The display will flash C00.
 - B. Press the UP button or DOWN button to cycle to C15.
 - C. Press the SETTING button
 - D. The display will flash OFF.
 - E. Press the UP button or DOWN button to cycle to dScI



Figure 14 - UIM display

- F. Press the SETTING button to activate the descaling mode.
7. Turn power to the pump on and let it run for approximately 45 minutes.
 8. Shut off power to the pump when descaling is complete.
 9. Close service valves A & B. See Figure 15.
 10. If possible connect the outlet hose to a drain or outside in order to flush the water heater. If unable, go to step 12.
 11. Open valve A to flush the water heater and remove loose scale and vinegar. Suggested flush time is approximately 10 minutes. Go to step 14.
 12. If unable to relocate the outlet hose to a drain or outside, confirm valves A and B are closed.
 13. Open valves C & D.
 14. Open the nearest hot water fixture to flush the water heater of any remaining vinegar. Suggested flush time is approximately 10 minutes.

NOTICE: DO NOT use a combined hot and cold fixture typically found in a shower.
 15. When flushing is complete, close all valves and remove all hoses.
 16. Press the SETTING button on the water heater's controller.
 17. Use the UP button or DOWN button to change the display from dScI to OFF.
 18. Press the SETTING button on the water heater's controller.
 19. Simultaneously press and hold the UP arrow and Setting button for approximately 6 seconds to enter normal operating mode.
 20. Turn on the gas supply valve.
 21. Open valves C & D.
 22. Open the nearest hot water fixture for a short time to test fire the heater and make sure there are no issues.

TROUBLESHOOTING

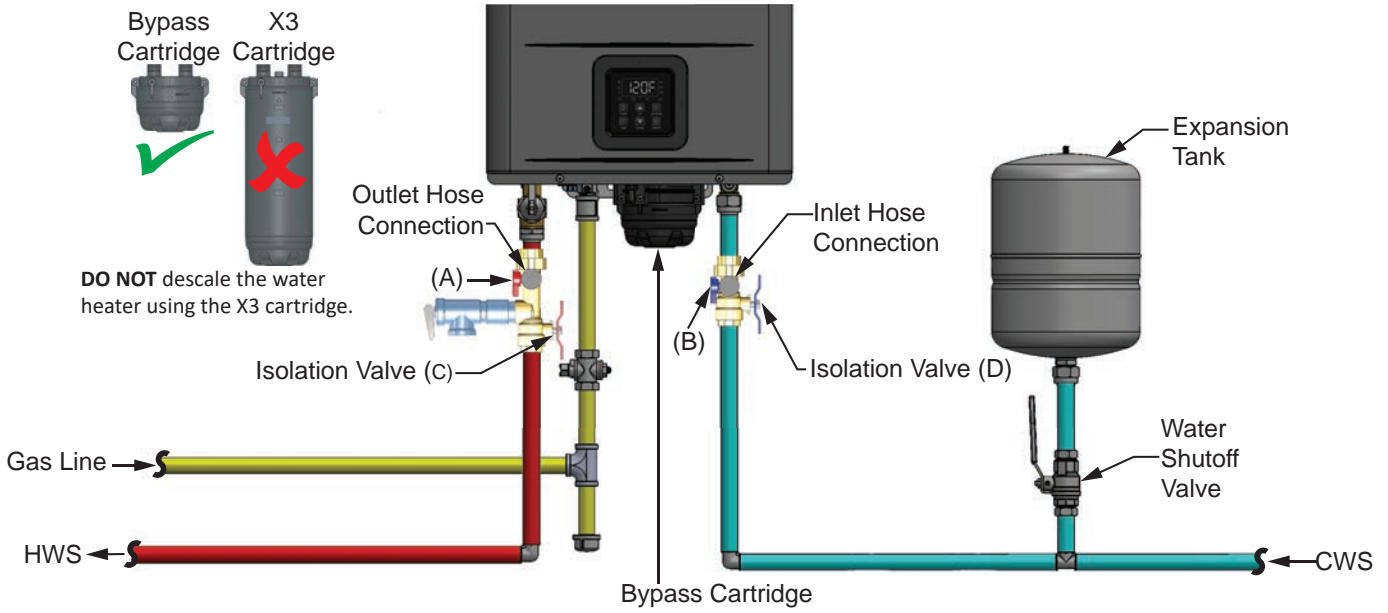

Figure 15 - Descaling the water heater

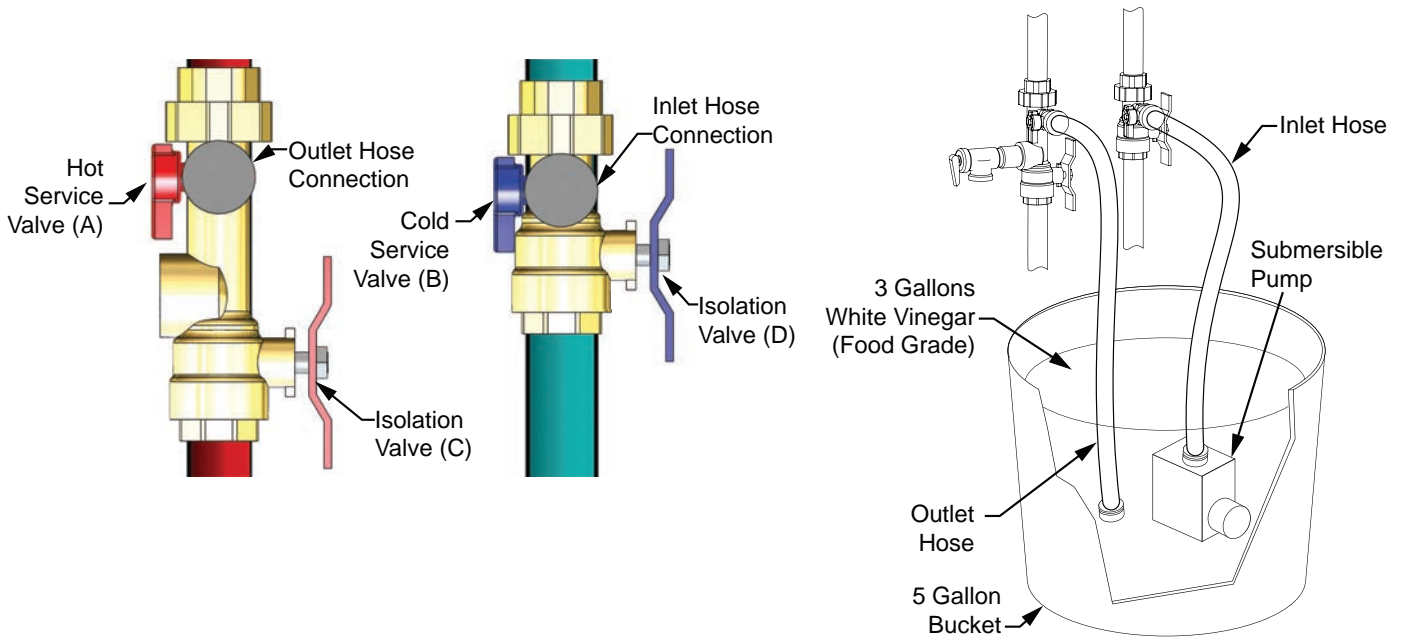

Figure 16 - Isolation valve connection points

NOTES

SERVICE

User Interface Module/Control Board Replacement Kit Instructions

Kit 100371204 Contains:

- User Interface Module
- Kit Instructions

Kit 100371187 Contains:

- Printed Circuit Board (THR-160)
- Kit Instructions

Kit 100371188 Contains:

- Printed Circuit Board (THR-180)
- Kit Instructions

Kit 100371189 Contains:

- Printed Circuit Board (THR-199)
- Kit Instructions

IMPORTANT: Use only factory authorized replacement parts. **DO NOT USE ELECTRIC SCREWDRIVERS OR DRILLS, HAND TIGHTEN ALL SCREWS TO PREVENT OVERTIGHTENING.** If you lack the necessary skills to properly perform the installation, you should not proceed, but get help from a qualified service technician.

Tools and Materials Required:

- Phillips Screwdriver
- Pliers
- Cable Tie (8 inch or greater)
- O-Ring Pick
- Safety Gloves

Preparing Water Heater for Service

1 Disconnect power to the water heater by unplugging it or by turning off the circuit at the breaker box, as appropriate. The power button on the water heater and remote **DOES NOT** disconnect power to the water heater. You must physically disconnect power to the water heater.

2 Locate the two screws at the bottom of the cabinet cover. Use a Phillips screwdriver to remove the screws. Place screws aside in a safe place for reinstallation

3 Lift cover up and away from cabinet to gain access to the water heater's internal components.

Removing the User Interface Module

4 Locate and disconnect the wiring harness connection point J shown in Figure 21.

5 Locate the user interface module on the bottom front of the water heater. See Figure 17.

Figure 17.

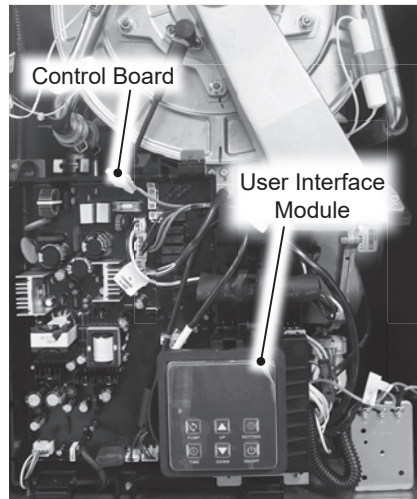

Figure 17 - User Interface Module

6 Locate the latch on the top of the user interface module. See Figure 18. Depress this latch and pull forward to remove the old user interface module from the mounting bracket.



Figure 18 - User Interface latch

7 Locate the four (4) screws securing the metal mounting plate. See Figure 19. Use a Phillips screwdriver to remove the screws. Place screws and mounting plate aside in a safe place for reinstallation.

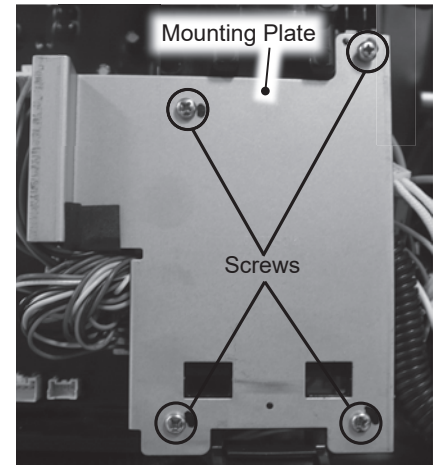

Figure 19 - Mounting plate screw removal.

8 Locate the screw securing the control board panel. Use a Phillips screwdriver to remove the screw and place it aside in a safe place for reinstallation. See Figure 4.

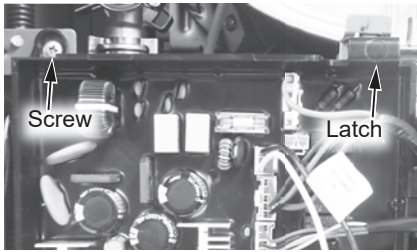

Figure 20 - Control board location

9 Press the latch at the top of the circuit board panel and pull the assembly forward from the top. It is hinged at the bottom and can be lowered. The circuit board assembly will hold itself in place.

10 Locate the push mount cable tie as shown in Figure 24. Use pliers to compress the wings and pull the user interface module wire to free it from the assembly.

11 Lift the circuit board panel up and lock into place.

12 The old user interface module is free from the assembly.

NOTICE: If only replacing the user interface module, dispose of it properly and proceed to **Step 35**. Proceed to the next section to remove the control board.

Removing the Control Board

13 Locate the control board on the bottom front of the water heater. See Figure 17.

14 Using Figure 21 as reference disconnect the wiring harnesses A through M from the control board.

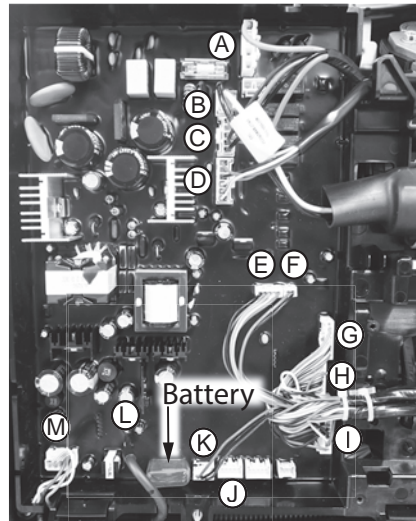

Figure 21 - Wiring harness connection points.

15 Connection points A, C - H, K, and M use a compression type harness. Grasp each harness in the middle and squeeze with a gentle pull to disconnect them.

16 Wiring harnesses B and I have plastic "keepers" to ensure the harnesses do not disconnect from the board. Use the following steps to assist in disconnecting those connections.

17 On connection point B, use an O-ring pick to apply pressure to the point shown in Figure 6 while pulling the harness from the board. Remove "keeper" and place aside in a safe place for reinstallation.

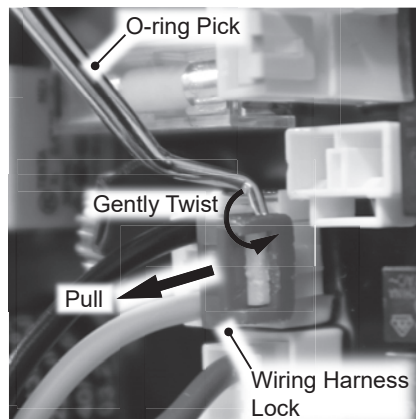

Figure 22 - Red harness lock removal

18 On connection point I, use an O-ring pick to apply pressure to the point shown in Figure 7 while pulling the harness from the board. Remove "keeper" and place aside in a safe place for reinstallation.

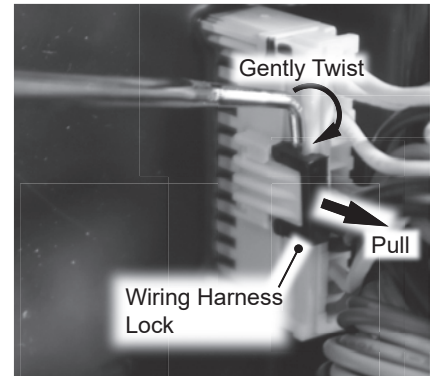

Figure 23 - Black harness lock removal

19 Connection point L, uses a standard blade style connector. Gently pull to remove.

20 At connection point M, free the wiring from the notch they are nested in.

21 Remove the cable tie shown in Figure 24. Route the now loose wiring away from the control board.

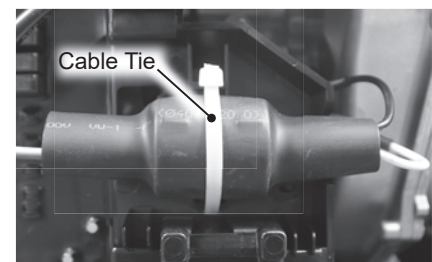

Figure 24 - Cable tie removal.

22 Press the latch at the top of the circuit board panel and pull the assembly forward from the top. It is hinged at the bottom and can be lowered. The circuit board assembly will hold itself in place.

SERVICES

23 Locate the wiring organizers on the back of the control board. Carefully remove the wiring from the organizers and route them aside.

24 Locate the two (2) push mount cable ties on the back of the control board. See Figure 25. Use a pair of pliers to compress tabs and push them out of the keeper holes.

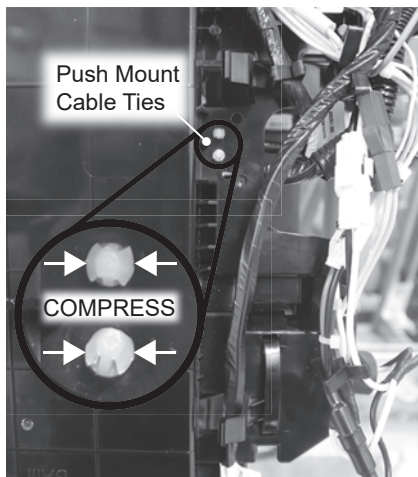

Figure 25 - Push mount cable tie removal.

25 Disconnect the push mount cable tie as shown in Figure 25.

26 With all wiring disconnected from the control board, lift control board until its hinges appear as shown in Figure 26.



Figure 26 - Removing the control board.

27 Remove the old control board from the water heater and dispose of properly.

Replacing the Control Board

28 Locate the new control board provided in the kit.

29 Align the hinge tabs on the control board with hinge mounts on the water heater.

The control board hinge tabs are oriented that it will connect when rotated to a specific angle. See Figure 26.

30 Re-route the wiring through the wiring organizers removed in **Step 23**.

31 Lift the circuit board panel up and lock into place.

32 Use a cable tie to secure the wiring removed in **Step 21**.

33 Reconnect the wiring harnesses removed in **Step 14**. Reference Figure 5 for placement of each wiring harness.

34 Reconnect the "keepers" on wiring harnesses B and I removed in **Steps 17 & 18**. Reference Figure 21 for placement of each wiring harness.

Replacing the User Interface Module

35 Reconnect the user interface module wiring harness removed in **Step 4**. Reference Figure 21 for connection point M.

36 Reinstall the metal mounting plate using the four (4) screws removed in **Step 7**. See Figure 19.

NOTICE: The user interface module wiring and other wiring is routed behind this plate.

37 Reinstall the original or replacement user interface module removed in **Step 6**.

Returning Water Heater to Operation

38 Lift the circuit board panel up and lock into place. Install and tighten the screw previously removed in **Step 8**.

39 If the new control board does not have a battery installed, remove the battery from the old control and place it in the new one. See Figure 21 for battery location.

40 Replace the cabinet cover and secure with the screws previously removed in **Step 2**.

41 Restore power to the water heater. The water heater is now ready for operation.

Burner Door Hi-Limit Replacement Kit Instructions

Kit 100371180 Contains:

- Burner Door Hi-Limit
- Kit Instructions

IMPORTANT: Use only factory authorized replacement parts. **DO NOT USE ELECTRIC SCREWDRIVERS OR DRILLS, HAND TIGHTEN ALL SCREWS TO PREVENT OVER TIGHTENING.** If you lack the necessary skills to properly perform the installation, you should not proceed, but get help from a qualified service technician.

Tools and Materials Required:

- Phillips Screwdriver
- Safety Gloves

Preparing Water Heater for Service

1 Disconnect power to the water heater by unplugging it or by turning off the circuit at the breaker box, as appropriate. The power button on the water heater and remote **DOES NOT** disconnect power to the water heater. You must physically disconnect power to the water heater.

Accessing Water Heater Components

2 Locate the two (2) screws at the bottom of the cabinet cover. Use a Phillips screwdriver to remove the screws. Place screws aside in a safe place for reinstallation.

3 Lift cover up and away from cabinet to gain access to the water heater's internal components.

Removing Burner Door Hi-Limit

4 Locate the burner door hi-limit on the burner assembly as shown in Figure 27. Disconnect the two (2) wire leads (labeled HI-LIMIT 1) from the hi-limit assembly and route them inside the water heater cabinet for ease of access to hi-limit. See Figure 27. Figure

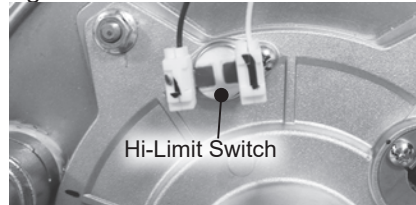

Figure 27 - Hi-Limit location

5 Use a Phillips screwdriver to remove the two (2) screws securing burner door hi-limit to the burner assembly. Place screws aside in a safe place for reinstallation. See Figure 28.

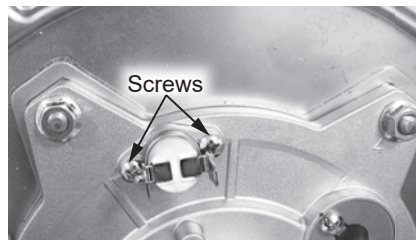

Figure 28 - Hi-Limit screw removal

6 Remove burner door hi-limit from burner assembly and dispose of properly.

Installing New Burner Door Hi-Limit

7 Locate the new burner door hi-limit assembly provided in the kit.

NOTICE: Confirm hi-limit is fully seated in bracket before installing to burner assembly.

8 Install the burner door hi-limit to the burner assembly. Secure with the two (2) screws previously removed in **Step 5**. Confirm hi-limit sits flush against burner assembly.

9 Connect the two (2) wire leads to the burner door hi-limit previously disconnected in **Step 4**. Confirm wire connections are secure.

Returning the Water Heater to Operation

10 Replace the cabinet cover and secure with the screws previously removed in **Step 2**.

11 Restore power to the water heater. The water heater is now ready for operation.

SERVICE

HEATER BLOCK WIRING ASSEMBLIES REPLACEMENT KIT INSTRUCTIONS

Kit 100371176 Contains:

- Long Heater Block Assembly
- Short Heater Block Assembly
- Kit Instructions

IMPORTANT: Use only factory authorized replacement parts. **DO NOT USE ELECTRIC SCREWDRIVERS OR DRILLS, HAND TIGHTEN ALL SCREWS TO PREVENT OVERTIGHTENING.** If you lack the necessary skills to properly perform the installation, you should not proceed, but get help from a qualified service technician.

Tools and Materials Required:

- 12" Phillips Screwdriver (magnetized)
- Mini Pick
- Safety Gloves

Preparing Water Heater for Service

1 Disconnect power to the water heater by unplugging it or by turning off the circuit at the breaker box, as appropriate. The power button on the water heater and remote **DOES NOT** disconnect power to the water heater. You must physically disconnect power to the water heater.

Accessing Water Heater Components

2 Locate the two (2) screws at the bottom of the cabinet cover. Use a Phillips screwdriver to remove the screws. Place screws aside in a safe place for reinstallation.

3 Lift cover up and away from cabinet to gain access to the water heater's internal components.

4 Locate the screw securing the control board panel as shown in Figure 1. Use a Phillips screwdriver to remove the screw and place it aside in a safe place for reinstallation.

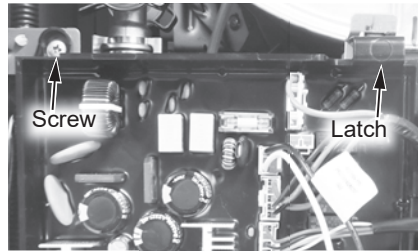

Figure 29 - Control board location

5 Press the latch at the top of the control board panel and pull the assembly forward from the top. It is hinged at the bottom and can be lowered. The control board assembly will hold itself in place.

(For Outdoor Units Only)

6 Locate the air inlet plate as shown in Figure 30. The air inlet plate can be removed to allow easy access to heater block inside hot outlet connection.

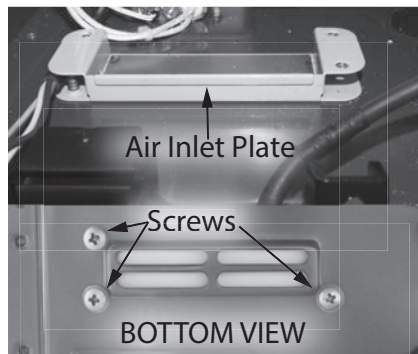

Figure 30 - Air inlet plate

7 Locate the three (3) screws securing the air inlet plate. Use a Phillips screwdriver to

remove the screws from under water heater cabinet. Place the screws and air inlet plate aside in a safe place for reinstallation.

NOTICE: When installed outdoors, the air inlet plate will be installed with the yellow side facing upward.

Removing Short Heater Block Assembly

8 Locate the heater block attached to the pump inlet elbow behind the flow control valve as shown in Figure 31.

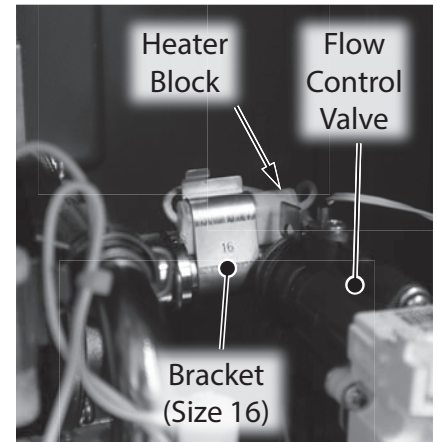

Figure 31 - Remove heater block

9 Remove bracket (size 16) securing heater block to pump inlet elbow. Place bracket aside in a safe place for reinstallation.

10 Locate the wire connection between the short heater block assembly and the long heater block assembly. Push tab to disconnect wires at connection point as shown in Figure 32.

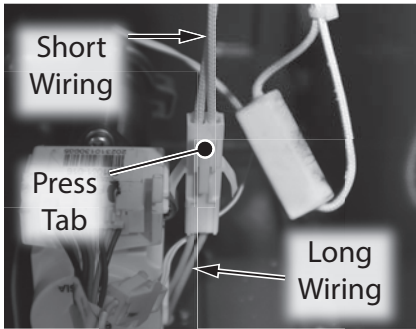

Figure 32 - Disconnect short heater block wiring from long heater block wiring

- 11 Remove short heater block assembly from water heater and dispose of properly.

Removing Long Heater Block Assembly

- 12 Locate the wire connection between the long heater block assembly and the reverse side of control board. To disconnect, gently remove the security clip with a mini pick or fingernail. Push tab as shown in Figure 33. Separate the harnesses. Place security clip aside in a safe place for reinstallation.

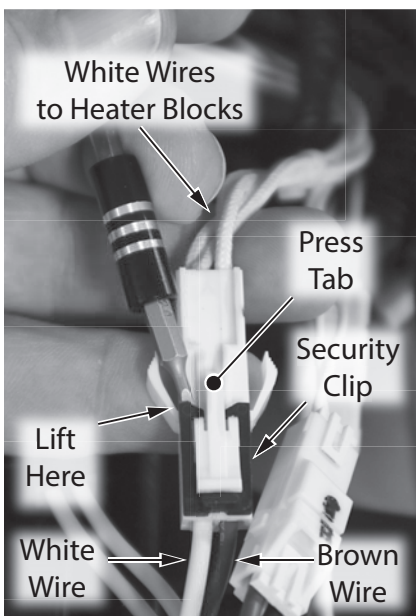

Figure 33 - Disconnect long heater block wiring from control board

- 13 Locate the screw securing the heater block inside the flow control valve as shown in Figure 6. Use a 12" Phillips screwdriver (magnetized) to remove screw. Place screw aside in a safe place for reinstallation. Remove heater block from flow control valve.

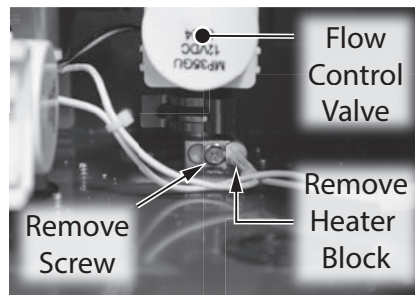

Figure 34 - Remove flow control heater block

- 14 Locate the screw securing the heater block inside the hot outlet connection as shown in Figure 35. Use a 12" Phillips screwdriver (magnetized) to remove screw. Place screw aside in a safe place for reinstallation. Remove heater block from hot outlet connection.

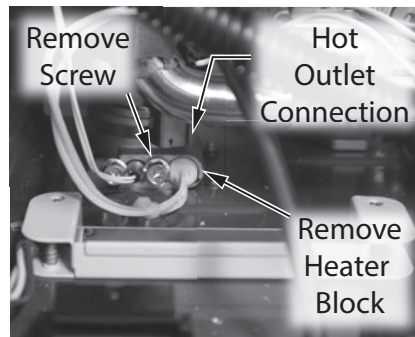

Figure 35 - Remove hot outlet connection heater block

- 15 Locate the five (5) remaining heater blocks attached to pipe connections as shown in Figure 36. Note the path of wires for ease of installation of new assembly. Remove brackets securing heater blocks to pipe connections. Place brackets aside in a safe place for reinstallation.

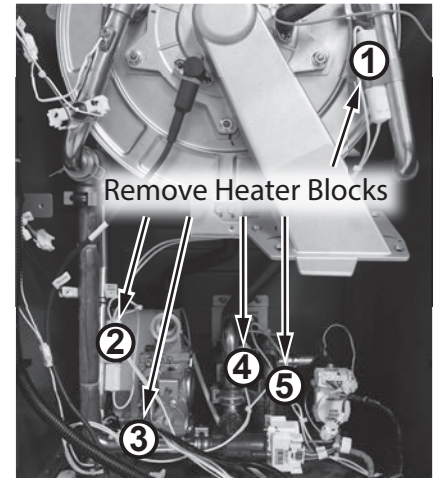

Figure 36 - Remove remaining heater blocks

- 16 Remove long heater block assembly from water heater and dispose of properly.

Installing New Long Heater Block Assembly

- 17 Locate the new, long heater block assembly provided in the kit. Install the five (5) heater blocks to pipe connections and secure with brackets previously removed in Step 15.

NOTICE: First secure heater block to pump outlet tube to ensure proper length of wire to connect long and short heater block assemblies later in Step 20. See Figure 9.

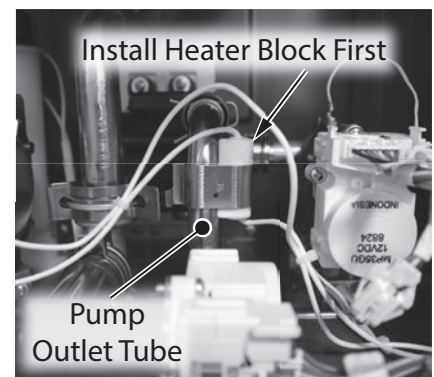

Figure 37 - Install pump outlet tube heater block

SERVICE

18 Locate the screw previously removed in **Step 14**. Insert heater block into hot outlet connection and secure with screw.

19 Locate the screw previously removed in **Step 13**. Insert heater block into flow control valve and secure with screw.

20 Connect new, long heater block assembly wires previously disconnected in **Step 12** to reverse side of control board. Secure wire harnesses with security clip. See Figure 38.

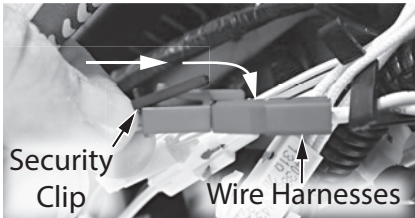

Figure 38 - Secure wiring with security clip

Installing New Short Heater Block Assembly

21 Locate the new, short heater block assembly provided in the kit. Install heater block to pump inlet elbow and secure with bracket previously removed in **Step 9**.

22 Connect long and short heater block assemblies previously disconnected in **Step 10**.

For indoor units, proceed to **Step 24**.

(For Outdoor Units Only)

23 Locate the air inlet plate and three (3) screws previously removed in **Step 7**. Orient air inlet plate so yellow side is facing up and the three (3) screw holes align. Install plate to water heater and secure with the three (3) screws.

Returning Water Heater to Operation

24 Lift the control board panel up and lock into place.

25 Install and tighten the screw to the control board panel previously removed in **Step 4**.

26 Replace the cabinet cover and secure with the screws previously removed in **Step 2**.

27 Restore power to the water heater. The water heater is now ready for operation.

FLAME SENSOR WIRE REPLACEMENT KIT INSTRUCTIONS

Kit 100371178 Contains:

- Flame Sensor Wire
- Kit Instructions

IMPORTANT: Use only factory authorized replacement parts. **DO NOT USE ELECTRIC SCREWDRIVERS OR DRILLS, HAND TIGHTEN ALL SCREWS TO PREVENT OVERTIGHTENING.** If you lack the necessary skills to properly perform the installation, you should not proceed, but get help from a qualified service technician.

Tools and Materials Required:

- Phillips Screwdriver
- Safety Gloves

Preparing Water Heater for Service

1 Disconnect power to the water heater by unplugging it or by turning off the circuit at the breaker box, as appropriate. The power button on the water heater and remote **DOES NOT** disconnect power to the water heater. You must physically disconnect power to the water heater.

Accessing Water Heater Components

2 Locate the two (2) screws at the bottom of the cabinet cover. Use a Phillips screwdriver to remove the screws. Place screws aside in a safe place for reinstallation.

3 Lift cover up and away from cabinet to gain access to the water heater's internal components.

Removing Flame Sensor Wire

4 Disconnect the flame sensor wire (blade style connector) from control board panel as shown in Figure 39. Notice the wire notch in the control board panel for proper routing of the flame sensor wire during reinstallation.

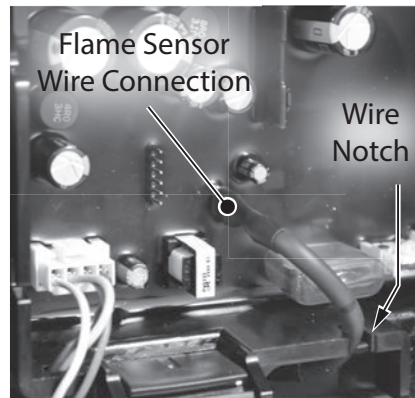

Figure 39 - Disconnect flame sensor wire

5 Locate the screw securing the control board panel as shown in Figure 40. Use a Phillips screwdriver to remove the screw and place it aside in a safe place for reinstallation.

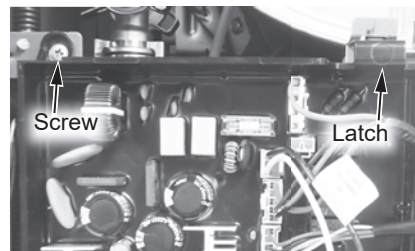

Figure 40 - Control board location

6 Press the latch at the top of the control board panel and pull the assembly forward from the top. It is hinged at the bottom and can be lowered. The control board panel will hold itself in place.

7 Locate the cap on flame sensor wire as shown in Figure 41. Pull cap from flame sensor in burner door and remove

flame sensor wire from water heater. Dispose of flame sensor wire properly.

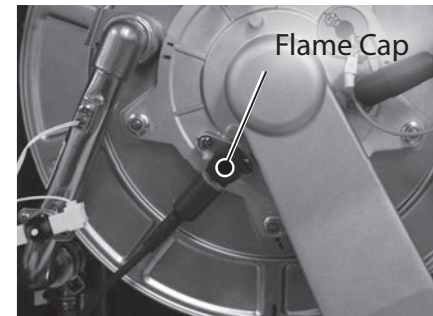

Figure 41 - Remove flame sensor cap

Installing New Flame Sensor Wire

8 Locate the new flame sensor wire provided in the kit.

9 Install cap on flame sensor wire to the flame sensor in burner door. The cap will click into place when secured.

10 Route the flame sensor wire under the control board panel and through the notch as shown in Figure 39. This will help keep wire in place.

11 Lift the control board panel up and lock into place.

12 Connect the flame sensor wire to control board panel as shown in Figure 39.

Returning Water Heater to Operation

13 Install and tighten the screw to the control board panel previously removed in **Step 5**.

14 Replace the cabinet cover and secure with the screws previously removed in **Step 2**.

15 Restore power to the water heater. The water heater is now ready for operation.

SERVICE

FREEZE PROTECTION THERMOSTAT REPLACEMENT KIT INSTRUCTIONS

Kit 100371197 Contains:

- Freeze Protection Thermostat
- Kit Instructions

IMPORTANT: Use only factory authorized replacement parts. **DO NOT USE ELECTRIC SCREWDRIVERS OR DRILLS, HAND TIGHTEN ALL SCREWS TO PREVENT OVERTIGHTENING.** If you lack the necessary skills to properly perform the installation, you should not proceed, but get help from a qualified service technician.

Tools and Materials Required:

- Phillips Screwdriver
- Safety Gloves

Preparing Water Heater for Service

1 Disconnect power to the water heater by unplugging it or by turning off the circuit at the breaker box, as appropriate. The power button on the water heater and remote **DOES NOT** disconnect power to the water heater. You must physically disconnect power to the water heater.

Accessing Water Heater Components

2 Locate the two (2) screws at the bottom of the cabinet cover. Use a Phillips screwdriver to remove the screws. Place screws aside in a safe place for reinstallation.

3 Lift cover up and away from cabinet to gain access to the water heater's internal components.

4 Locate the screw securing the control board panel as shown in Figure 42. Use a Phillips screwdriver to remove the screw and place it aside in a safe place for reinstallation.

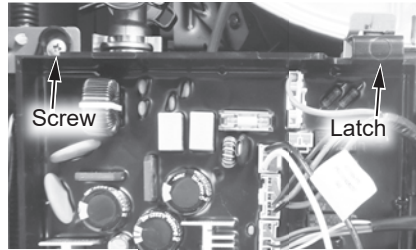

Figure 42 - Control board location

5 Press the latch at the top of the control board panel and pull the assembly forward from the top. It is hinged at the bottom and can be lowered. The control board panel will hold itself in place.

Removing Freeze Protection Thermostat

6 With control board panel lowered, locate the freeze protection thermostat wire connection (white) as shown in Figure 43. Press tab on connector and disconnect wires. Wires leading to control board are white and brown. Wires leading to thermostat are both white.

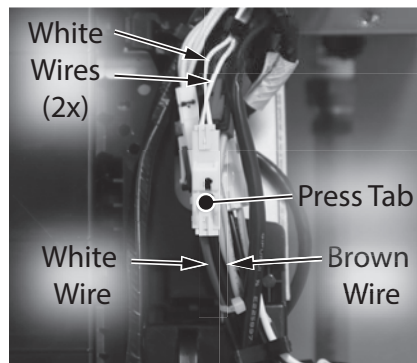

Figure 43 - Disconnect thermostat wiring

7 Locate freeze protection thermostat installed to the outlet water tube as shown in Figure 44. The thermostat is secured to tubing by a metal clamp. To remove thermostat from piping, gently pull on metal clamp and the assembly will come free. Dispose of properly.

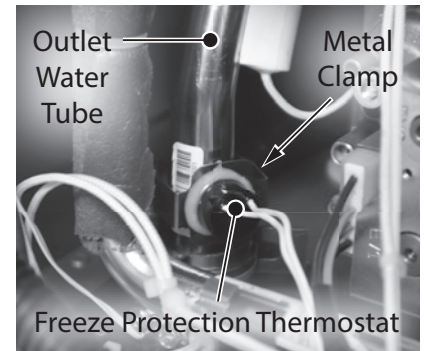

Figure 44 - Remove freeze protection thermostat

Installing New Free Protection Thermostat

- 8** Locate the new freeze protection thermostat provided in the kit.
- 9** To install freeze protection thermostat to outlet water tube, gently push metal clamp onto tubing. The metal clamp will snap into place. Confirm thermostat sits flush against piping.
- 10** Connect freeze protection thermostat to wiring cluster located at the control board panel as shown in Figure 43. Confirm wiring is snug inside plastic organizer.

Returning Water Heater to Operation

- 11** Lift the control board panel up and lock into place.
- 12** Install and tighten the screw to the control board panel previously removed in **Step 4**.

13 Replace the cabinet cover and secure with the screws previously removed in **Step 2**.

14 Restore power to the water heater. The water heater is now ready for operation.

MAIN WIRING HARNESS REPLACEMENT KIT INSTRUCTIONS

Kit 100371210 Contains:

- Main Wiring Harness
- Kit Instructions

IMPORTANT: Use only factory authorized replacement parts. **DO NOT USE ELECTRIC SCREWDRIVERS OR DRILLS, HAND TIGHTEN ALL SCREWS TO PREVENT OVER TIGHTENING.** If you lack the necessary skills to properly perform the installation, you should not proceed, but get help from a qualified service technician.

Tools and Materials Required:

- Phillips Screwdriver
- Pliers
- O-Ring Pick
- Safety Gloves

Preparing Water Heater for Service

1 Disconnect power to the water heater by unplugging it or by turning off the circuit at the breaker box, as appropriate. The power button on the water heater and remote **DOES NOT** disconnect power to the water heater. You must physically disconnect power to the water heater.

2 Locate the two screws at the bottom of the cabinet cover. Use a Phillips screwdriver to remove the screws. Place screws aside in a safe place for reinstallation.

3 Lift cover up and away from cabinet to gain access to the water heater's internal components.

Removing the Main Wiring Harness

4 Locate the outlet thermistor wiring harness labeled "EXHAUST" and disconnect it. See Figure 45.

5 Locate the burner hi-limit switch wire leads labeled "HI LIMIT 1" and disconnect them. See Figure 45.

6 Locate the pressure switch wire leads labeled "WIND" and disconnect them. See Figure 45.

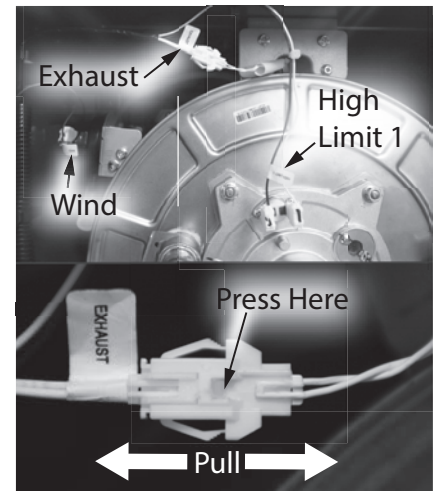

Figure 45 - First wiring harness bundle location

7 Remove the harness from the plastic organizers on the left side of the water heater cabinet.

8 Locate and disconnect the "HI LIMIT 2" wire leads and "HEX" thermistor wiring harness shown in Figure 46.

SERVICE

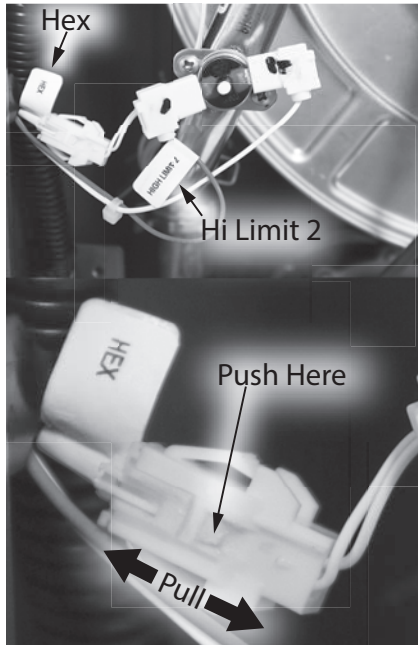

Figure 46 - Second wiring harness bundle location

- 9 Locate the screw securing the control board panel. Use a Phillips screwdriver to remove the screw and place it aside in a safe place for reinstallation. See Figure 3.

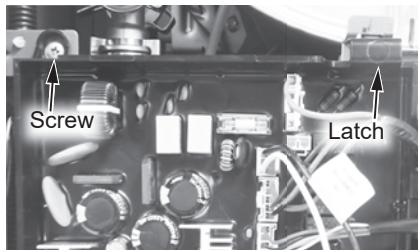

Figure 47 - Control board location

- 10 Press the latch at the top of the control board panel and pull the assembly forward from the top. It is hinged at the bottom and can be lowered. The circuit board assembly will hold itself in place.

- 11 Locate the third bundle of wiring harnesses shown in Figure 4. Disconnect the following harnesses: MICRO SWITCH, VENTURI, LIQUID LEVEL, and OUTLET.

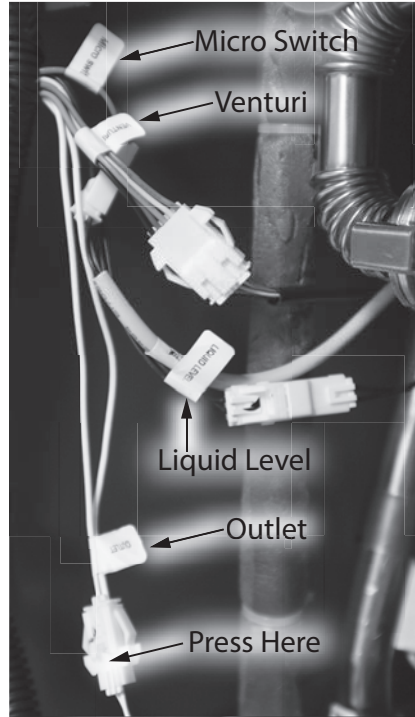

Figure 48 - Third bundle of wiring harnesses

- 12 Use pliers to release the push mount cable tie securing the wiring harness to the water heater cabinet.
- 13 Locate the push mount securing the wiring harness to the back of the control panel.

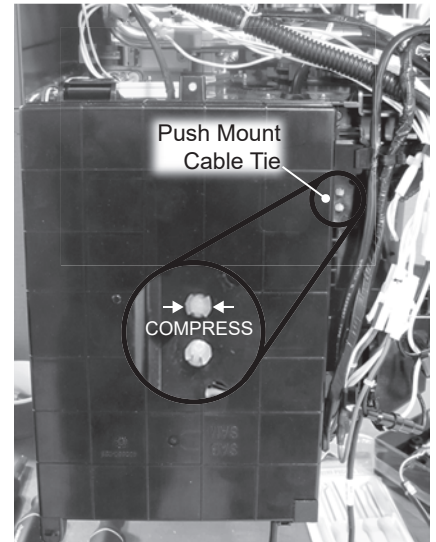

Figure 49 - Locating the push mount connector

- 14 Lift the control board panel up and lock into place.
- 15 Locate the latch on the top of the user interface module. See Figure 50. Depress this latch and pull forward to remove the user interface module from the mounting bracket.



Figure 50 - User Interface latch

- 16** Locate the four (4) screw securing the metal mounting plate. See Figure 51. Use a Phillips screwdriver to remove the screws. Place screws and mounting plate aside in a safe place for reinstallation.

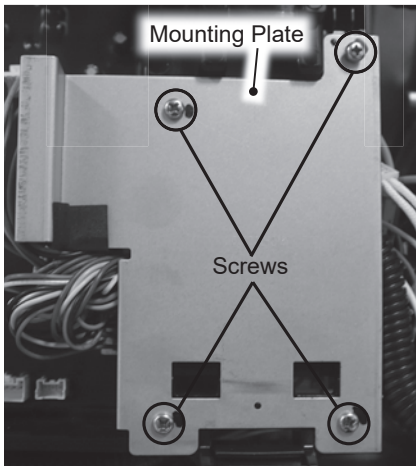

Figure 51 - Mounting plate screw removal.

- 17** Using Figure 52, remove harnesses E - I and K.

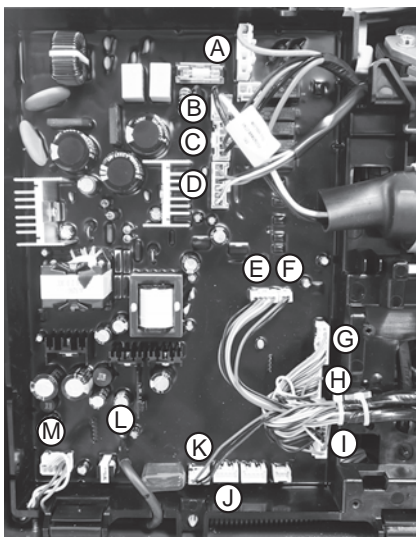

Figure 52 - Wiring harness connection points.

- 18** On connection point I, use an O-ring pick to apply pressure to the point shown in Figure 9 while pulling the harness from the board. Remove "keeper" and place aside in a safe place for reinstallation.

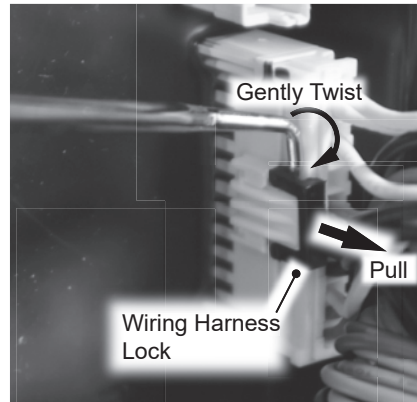

Figure 53 - Black harness lock removal

- 19** Press the latch at the top of the control board panel and pull the assembly forward from the top. It is hinged at the bottom and can be lowered. The circuit board assembly will hold itself in place.

- 20** Locate the blue wiring harness labeled "WATER VALVE" at the bypass module and disconnect it. See Figure 54.

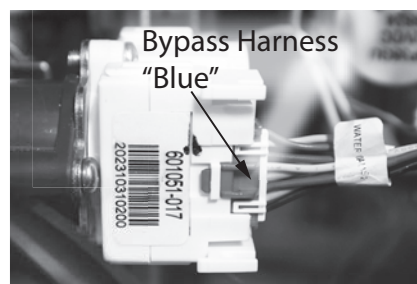

Figure 54 - Bypass valve harness location

- 21** Locate the three (3) wiring harness at the inlet flow module and disconnect them. See Figure 55.

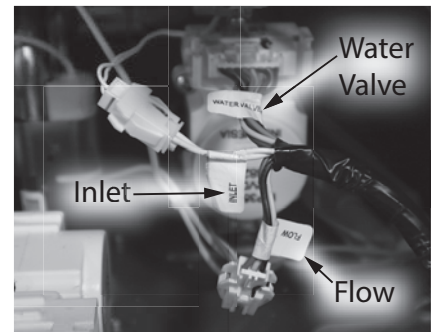

Figure 55 - Location of inlet flow module harnesses

- 22** To disconnect the "INLET" harness, reference Figure 56.

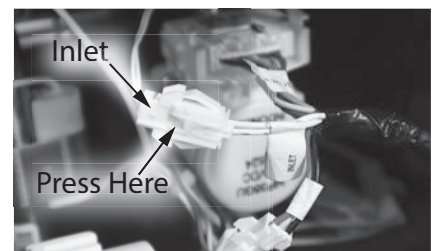

Figure 56 - Inlet harness disconnect instructions

- 23** Remove the old main wiring harness and dispose of it properly.

Replacing the Gas Wiring Harness

- 24** Locate the new gas wiring harness in the provided in the kit.
- 25** Reconnect the end of the new main wiring harness to the three (3) wiring harnesses removed in **Step 21**. See Figure 55.
- 26** Reconnect the blue wiring harness removed in **Step 20**, to the bypass cartridge See Figure 10.

SERVICE

27 Lift the circuit board panel up and lock into place.

28 Reconnect wiring harnesses E - I, and K removed in **Step 17**.

29 Reconnect the wiring harness lock removed in **Step 18**.

30 Reconnect wiring through the plastic organizers.

31 Reinstall the metal mounting plate using the four (4) screws removed in **Step 16**.

NOTICE: Route the wiring harnesses behind the metal mounting plate.

32 Press the latch at the top of the control board panel and pull the assembly forward from the top. It is hinged at the bottom and can be lowered. The circuit board assembly will hold itself in place.

33 Reconnect the group of wiring harnesses removed in **Step 11**.

34 Lift the circuit board panel up and lock into place. Install and tighten the screw previously removed in **Step 9**.

35 Reconnect the group of wiring harnesses removed in **Step 8**.

36 Route the wiring through the plastic organizers removed in **Step 7**.

37 Reconnect the pressure switch wire leads removed in **Step 6**.

NOTICE: The red connection is on the right and black connection is on the left.

38 Reconnect the hi-limit switch wire leads removed in **Step 5**.

39 Reconnect the hot outlet thermistor switch wiring harness removed in **Step 4**.

40 Check to ensure all cables are stowed and will not interfere with operation.

Returning Water Heater to Operation

41 Replace the cabinet cover and secure with the screws previously removed in **Step 2**.

42 Restore power to the water heater. The water heater is now ready for operation.

GAS WIRING HARNESS REPLACEMENT KIT INSTRUCTIONS

Kit 100371211 Contains:

- Gas Wiring Harness
- Kit Instructions

IMPORTANT: Use only factory authorized replacement parts. **DO NOT USE ELECTRIC SCREWDRIVERS OR DRILLS, HAND TIGHTEN ALL SCREWS TO PREVENT OVERTIGHTENING.** If you lack the necessary skills to properly perform the installation, you should not proceed, but get help from a qualified service technician.

Tools and Materials Required:

- Phillips Screwdriver
- Pliers
- O-Ring Pick
- Safety Gloves

Preparing Water Heater for Service

- 1 Disconnect power to the water heater by unplugging it or by turning off the circuit at the breaker box, as appropriate. The power button on the water heater and remote **DOES NOT** disconnect power to the water heater. You must physically disconnect power to the water heater.
- 2 Locate the two screws at the bottom of the cabinet cover. Use a Phillips screwdriver to remove the screws. Place screws aside in a safe place for reinstallation.
- 3 Lift cover up and away from cabinet to gain access to the water heater's internal components.

Removing the Gas Wiring Harness

- 4 Locate the ignitor wiring harness and ignitor ground connection. See Figure 57. Disconnect them and move the wires aside.

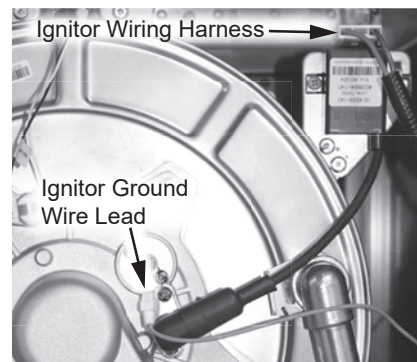

Figure 57 - Ignitor wiring harness location

- 5 The wiring is held in place along the right side of the cabinet by three (3) plastic organizers. Remove the wiring from these keepers.
- 6 Locate and remove the two (2) screws securing the grounding wires to the grounding plate. See Figure 57. Do not remove the third ground connection that is not part of the wiring assembly. Place screws aside in a safe place for reinstallation.



Figure 58 - Location of ground wires

NOTICE: Remove the push mount cable tie securing the wiring assembly to the ground plate.

- 7 Using Figure 59 & Figure 60 as reference, disconnect wiring harness A and B from the control board.

NOTICE: To remove wiring harness **(A)**, depress the spot shown in Figure 59 while pull the harness away from the control board.

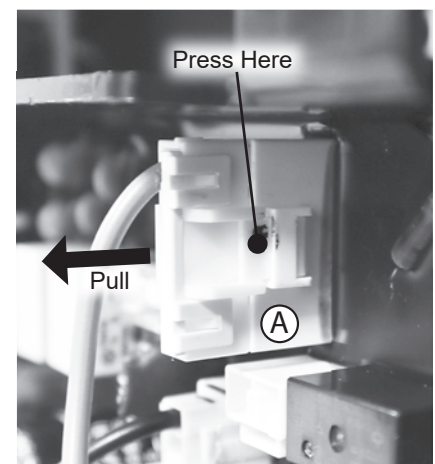

Figure 59 - Wiring harness A removal.

- 8 Disconnect wiring harness **(B)** shown in Figure 60.

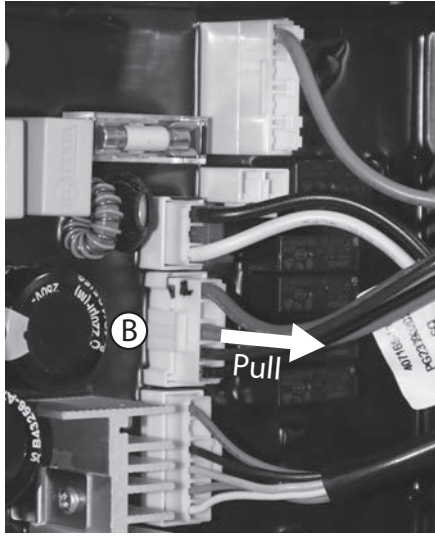

Figure 60 - Wiring harness location

9 Locate the screw securing the control board panel. Use a Phillips screwdriver to remove the screw and place it aside in a safe place for reinstallation.



Figure 61 - Control board screw location

10 Press the latch at the top of the circuit board panel and pull the assembly forward from the top. It is hinged at the bottom and can be lowered. The circuit board assembly will hold itself in place.

11 Remove the wiring assembly from the plastic organizers on the back of the control board.

12 Locate the screw securing the wiring harness to the gas valve. See Figure 62. Use a Phillips screwdriver to remove the screw and place it aside in a safe place for reinstallation.

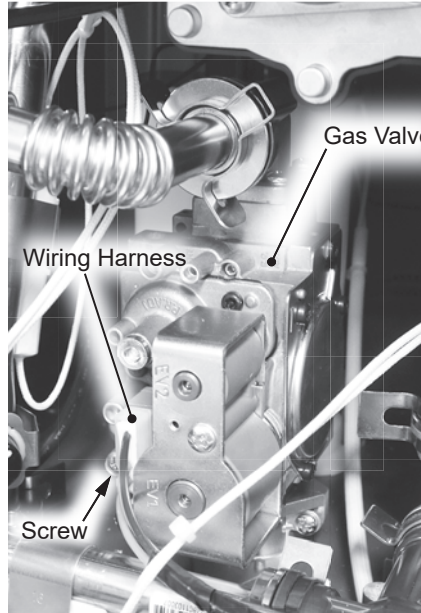

Figure 62 - Gas valve wiring harness location.

13 Remove the old gas wiring harness and dispose of it properly.

Replacing the Gas Wiring Harness

14 Locate the new gas wiring harness provided in the kit.

15 Reconnect the gas valve wiring harness and secure with screw removed in **Step 12**.

16 Route the wiring through the cable organizer removed in **Step 11**.

17 Lift the circuit board panel up and lock into place. Install and tighten the screw previously removed in **Step 9**.

18 Reconnect wiring harnesses A and B removed in **Step 7 & 8**.

19 Using the screws removed in **Step 6**, reconnect the ground wires to the grounding plate.

20 Reroute the wiring assembly through the plastic organizers on the right side of the cabinet removed in **Step 5**.

21 Reconnect the ignitor ground connection and ignitor wiring harness removed in **Step 4**.

Returning Water Heater to Operation

22 Replace the cabinet cover and secure with the screws previously removed in **Step 2**.

23 Restore power to the water heater. The water heater is now ready for operation.

FLUE/AIR INTAKE CLAMP REPLACEMENT KIT INSTRUCTIONS

Kit 100371167 Contains:

- Clamps
- Kit Instructions

IMPORTANT: Use only factory authorized replacement parts. **DO NOT USE ELECTRIC SCREWDRIVERS OR DRILLS, HAND TIGHTEN ALL SCREWS TO PREVENT OVER TIGHTENING.** If you lack the necessary skills to properly perform the installation, you should not proceed, but get help from a qualified service technician.

Tools and Materials Required:

- Flathead Screwdriver
- Phillips head Screwdriver
- Safety Gloves

Preparing Water Heater for Service

1 Disconnect power to the water heater by unplugging it or by turning off the circuit at the breaker box, as appropriate. The power button on the water heater and remote **DOES NOT** disconnect power to the water heater. You must physically disconnect power to the water heater.

2 Locate the flue exhaust port and intake air port. See Figure 63.

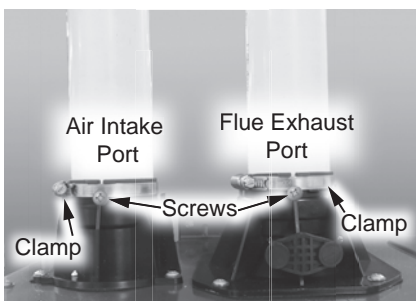

Figure 63 - Flue exhaust port and intake air port location

3 Remove the two (2) screws securing the intake air and exhaust piping to the ports. Place the screws aside in a safe place for reinstallation. See Figure 63.

Removing the Flue/Air Intake Clamps

4 Using a flathead screwdriver loosen the exhaust port and air intake clamps.

5 Disconnect the flue exhaust pipe from the exhaust port and air intake pipe from the air intake port.

6 Remove the clamps and dispose of them properly.

Replacing the Flue/Air Intake Clamps

7 Locate the new clamps provided in the kit. Place a new clamp over the intake air port and the exhaust port. Note the orientation of the clamps. See Figure 1

8 Reinstall the flue exhaust pipe to the exhaust port and air intake pipe to the air intake port removed in **Step 5**.

NOTICE: Before placing the pipes into the ports make sure they are clean and free from any debris.

9 Reinstall the two (2) screws removed in **Step 3**. See Figure 63.

10 Tighten the clamps at the exhaust and intake air ports to secure the piping.

Returning Water Heater to Operation

11 Restore power to the water heater. The water heater is now ready for operation.

SERVICE

EMISSION PORT CAP REPLACEMENT KIT INSTRUCTIONS

Kit 100371166 Contains:

- Emission Port Cap
- Kit Instructions

IMPORTANT: Use only factory authorized replacement parts. **DO NOT USE ELECTRIC SCREWDRIVERS OR DRILLS, HAND TIGHTEN ALL SCREWS TO PREVENT OVER TIGHTENING.** If you lack the necessary skills to properly perform the installation, you should not proceed, but get help from a qualified service technician.

Tools and Materials Required:

- Phillips Screwdriver
- Safety Gloves

WARNING!
This kit shall be installed by a qualified service agency in accordance with the manufacturer's instructions and all applicable codes and requirements of the authority having jurisdiction. The information in these instructions must be followed to minimize the risk of fire or explosion or to prevent property damage, personal injury or death. The qualified service agency is responsible for the proper installation of this kit.

SERVICE

Preparing Water Heater for Service

1 Disconnect power to the water heater by unplugging it or by turning off the circuit at the breaker box, as appropriate. The power button on the water heater and remote **DOES NOT** disconnect power to the water heater. You must physically disconnect power to the water heater.

2 Shut **OFF** the gas supply to the water heater at the manual gas shut off valve.

Removing Emissions Port Cap

3 Locate the emission port cap at the outlet exhaust port on the water heater as shown in

FFigure 64.

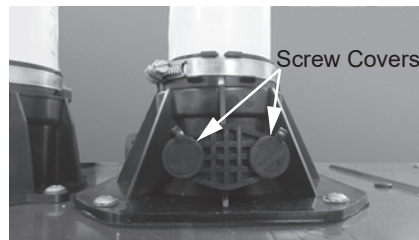

Figure 64 - Emission port location

4 Lift the screw covers to reveal the screws securing emission port cap to exhaust port.

5 Remove screws and set aside in a safe place for reinstallation. See Figure 65.

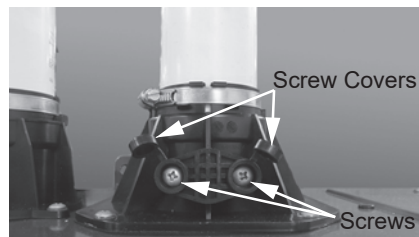

Figure 65 - Emissions port screw removal

6 Remove emission port cap and dispose of properly.

Installing New Emission Port Cap

7 Locate the new emission port cap provided in the kit.

8 Orient cap such that the plug can be inserted into the outlet exhaust port. Install cap to outlet exhaust port.

9 Locate screws previously removed in **Step 5**. Use screws to secure cap to outlet exhaust port. Cover screws with screw covers.

Checking for Gas Leaks

10 Turn **ON** the gas supply to the water heater at the manual gas shut off valve.

11 Restore power to the water heater.

12 Open all hot water fixtures in the house. This will initiate the call for heat at the water heater.

13 Check for leaks around the emission port cap. Use a small, soft-bristled brush to apply a hand dishwashing soap and water mixture (1 part soap to 15 parts water) or children's soap bubbles around the emissions port cap. If any leaks are detected (which will appear as small bubbles), resecure the emission port cap and recheck for leaks.

Returning the Water Heater to Operation

14 The water heater is ready for operation once there are no leaks detected at the emission port cap

GAS CONNECTOR REPLACEMENT KIT INSTRUCTIONS

Kit 100371172 Contains:

- Gas Connector
- Gas Valve O-ring
- Kit Instructions

IMPORTANT: Use only factory authorized replacement parts. **DO NOT USE ELECTRIC SCREWDRIVERS OR DRILLS, HAND TIGHTEN ALL SCREWS TO PREVENT OVERTIGHTENING.** If you lack the necessary skills to properly perform the installation, you should not proceed, but get help from a qualified service technician.

Tools and Materials Required:

- Phillips Screwdriver
- Pipe Wrench
- Thread Sealant Tape or Pipe Dope
- Safety Gloves

WARNING!

This kit shall be installed by a qualified service agency in accordance with the manufacturer's instructions and all applicable codes and requirements of the authority having jurisdiction. The information in these instructions must be followed to minimize the risk of fire or explosion or to prevent property damage, personal injury or death. The qualified service agency is responsible for the proper installation of this kit.

Preparing Water Heater for Service

- 1 Disconnect power to the water heater by unplugging it or by turning off the circuit at the breaker box, as appropriate. The power button on the water heater and remote **DOES NOT** disconnect power to the water heater. You must physically disconnect power to the water heater.
- 2 Shut **OFF** the gas supply to the water heater at the manual gas shut off valve.
- 3 Locate the gas connector on the bottom of the water heater. See Figure 66. Disconnect the gas line to the water heater.

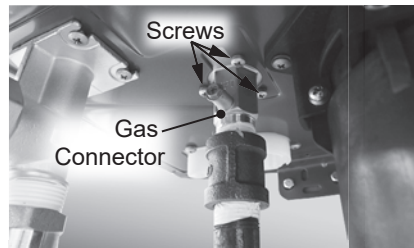

Figure 66 - Gas connector location

- 4 Locate the two screws at the bottom of the cabinet cover. Use a Phillips screwdriver to remove the screws. Place screws aside in a safe place for reinstallation.
- 5 Lift cover up and away from cabinet to gain access to the water heater's internal components.

Removing the Gas Connector

- 6 Locate the screw securing the control board panel. Use a Phillips screwdriver to remove the screw and place it aside in a safe place for reinstallation. See Figure 67.

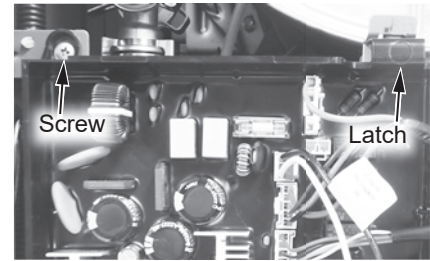

Figure 67 - Control board location

- 7 Press the latch at the top of the circuit board panel and pull the assembly forward from the top. It is hinged at the bottom and can be lowered. The circuit board assembly will hold itself in place.
- 8 Locate the gas valve at the bottom left side of the water heater. See Figure 67.

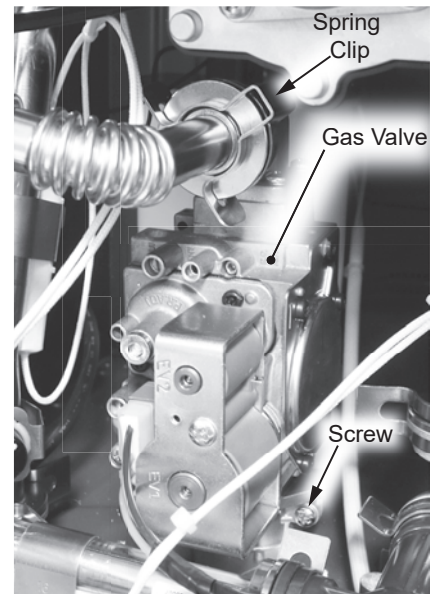

Figure 68 - Gas valve location

- 9 Locate and remove the spring clip securing the gas valve to the gas piping system. Note its orientation and place it aside for reinstallation. See Figure 67.
- 10 Remove and keep the screw at base of the gas valve. See Figure 67.

SERVICE

- 11 Remove the gas valve and set aside for reinstallation.

NOTE: It is not necessary to remove the gas valve from the water heater, it can be set aside in the case.

- 12 Locate the three (3) screws securing the gas connector to the base of the base of the cabinet. Use a Phillips screwdriver to remove the screws and place them aside in a safe place for reinstallation. See Figure 66.

- 13 Remove the old gas connector and dispose of properly.

Replacing the Gas Connector

- 14 Locate the new O-ring included in the kit, install it as shown in Figure 69.

NOTICE: Handle with care and verify lubricant has been applied to O-ring and O-ring is not dirty or damaged.

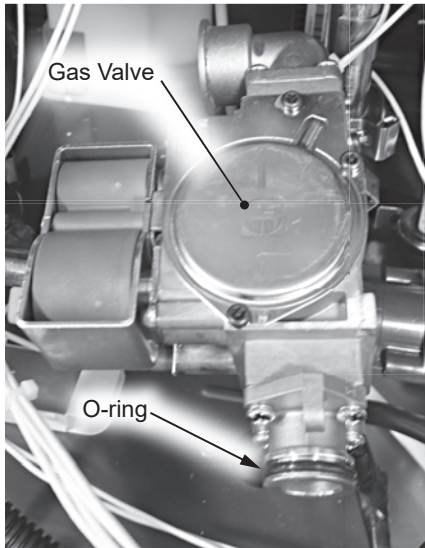

Figure 69 - Gas valve o-ring

- 15 Install the new gas connector in the base of the cabinet and secure with the three (3) screws removed in **Step 12**.

- 16 Carefully install the gas valve to the gas connector. Secure with the screw removed in

Step 10.

NOTICE: Check the fittings for any dirt or debris before making the connection.

- 17 Locate the spring clip previously removed in **Step 9**. Install spring clip to gas valve securing it to gas connector.

- 18 Reconnect the gas line to the gas connector. Use an approved thread sealant tape or pipe dope when making the connection.

Checking for Gas Leaks

- 19 Turn **ON** the gas supply to the water heater at the manual gas shut off valve and check for leaks. Use a small, soft-bristled brush to apply a hand dishwashing soap and water mixture (1 part soap to 15 parts water) or children's soap bubbles around the gas valve connector. If any leaks are detected (which will appear as small bubbles), resecure the connection and recheck for leaks.

Returning Water Heater to Operation

- 20 Lift the circuit board panel up and lock into place. Install and tighten the screw previously removed in **Step 6**.

- 21 Replace the cabinet cover and secure with the screws previously removed in **Step 4**.

- 22 Restore power to the water heater. The water heater is now ready for operation.

PRESSURE SWITCH REPLACEMENT KIT INSTRUCTIONS

Kit 100371190 Contains:

- Pressure Switch 100371081
- Kit Instructions

IMPORTANT: Use only factory authorized replacement parts. **DO NOT USE ELECTRIC SCREWDRIVERS OR DRILLS, HAND TIGHTEN ALL SCREWS TO PREVENT OVERTIGHTENING.** If you lack the necessary skills to properly perform the installation, you should not proceed, but get help from a qualified service technician.

Tools and Materials Required:

- Phillips Screwdriver
- Safety Gloves

Preparing Water Heater for Service

1 Disconnect power to the water heater by unplugging it or by turning off the circuit at the breaker box, as appropriate. The power button on the water heater and remote **DOES NOT** disconnect power to the water heater. You must physically disconnect power to the water heater.

2 Locate the two screws at the bottom of the cabinet cover. Use a Phillips screwdriver to remove the screws. Place screws aside in a safe place for reinstallation.

3 Lift cover up and away from cabinet to gain access to the water heater's internal components.

Removing the Pressure Switch

4 Locate the pressure switch on upper left side of the water heater. See Figure 70.

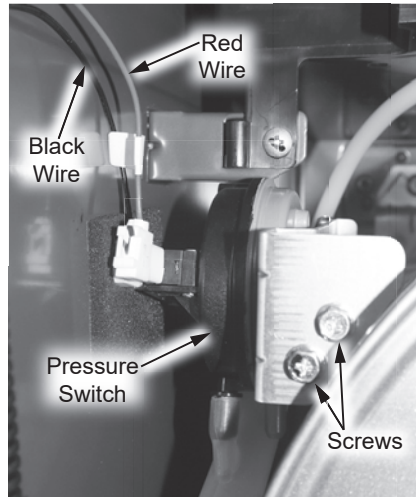

Figure 70 - Pressure switch location

5 Disconnect the black wire harness from the common (C) connector and the red wire harness from the normally closed (NC) connector. See Figure 70.

6 Remove and keep the two screws securing the pressure switch to the water heater. See Figure 70.

7 Carefully pull the pressure switch from the water heater and disconnect the pressure tubing from the pressure switch.

NOTICE: Be careful not to damage the pressure tubing. See Figure 71.

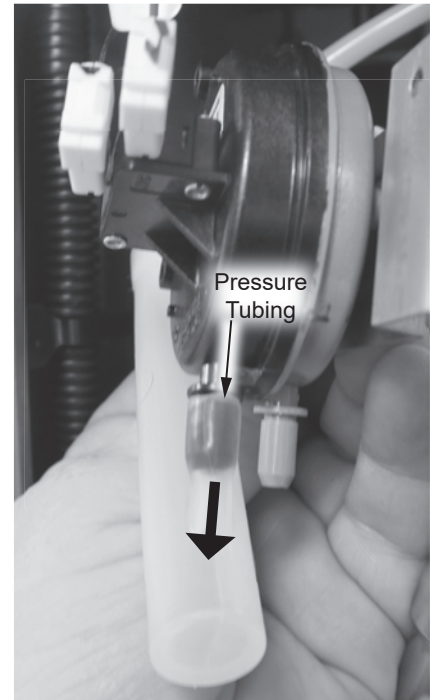

Figure 71 - Removing the pressure tube

8 Remove and keep the two screws securing the pressure switch to the mounting bracket.

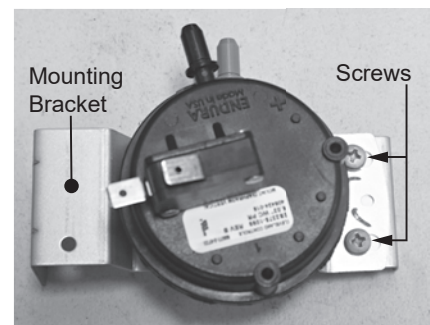

Figure 72 - Pressure switch mounting bracket

9 Dispose of the old pressure switch properly.

Replacing the Pressure Switch

- 10 Locate the pressure switch provided in the kit.
- 11 Mount the new pressure switch to the mounting bracket. Secure with the two screw removed in **Step 8**.
- 12 Reconnect the pressure tubing as shown in Figure 3.
- 13 Reconnect the pressure switch to the water heater and secure with the two screws removed in **Step 6**.
- 14 Reconnect the black wire harness to the common (C) connector. Reconnect red wire harness to the normally closed (NC) connector. See Figure 70.

Returning the Water Heater to Operation

- 15 Replace the cabinet cover and secure with the screws previously removed in **Step 2**.
- 16 Restore power to the water heater. The water heater is now ready for operation.

FLAME SENSOR ASSEMBLY REPLACEMENT KIT INSTRUCTIONS

Kit 100371170 Contains:

- Flame Sensor Assembly
- Graphite Gasket
- Kit Instructions

IMPORTANT: Use only factory authorized replacement parts. **DO NOT USE ELECTRIC SCREWDRIVERS OR DRILLS, HAND TIGHTEN ALL SCREWS TO PREVENT OVER TIGHTENING.** If you lack the necessary skills to properly perform the installation, you should not proceed, but get help from a qualified service technician.

Tools and Materials Required:

- Phillips Screwdriver
- Safety Gloves

WARNING!
This kit shall be installed by a qualified service agency in accordance with the manufacturer's instructions and all applicable codes and requirements of the authority having jurisdiction. The information in these instructions must be followed to minimize the risk of fire or explosion or to prevent property damage, personal injury or death. The qualified service agency is responsible for the proper installation of this kit.

Preparing Water Heater for Service

- 1 Disconnect power to the water heater by unplugging it or by turning off the circuit at the breaker box, as appropriate. The

power button on the water heater and remote **DOES NOT** disconnect power to the water heater. You must physically disconnect power to the water heater.

- 2 Shut **OFF** the gas supply to the water heater at the manual gas shut off valve.

Accessing Water Heater Components

- 3 Locate the two (2) screws at the bottom of the cabinet cover. Use a Phillips screwdriver to remove the screws. Place screws aside in a safe place for reinstallation.
- 4 Lift cover up and away from cabinet to gain access to the water heater's internal components.

Removing Flame Sensor Assembly

- 5 Locate the flame sensor on the burner assembly as shown in Figure 73. Remove the cap from the flame sensor. **DO NOT** pull on wires.

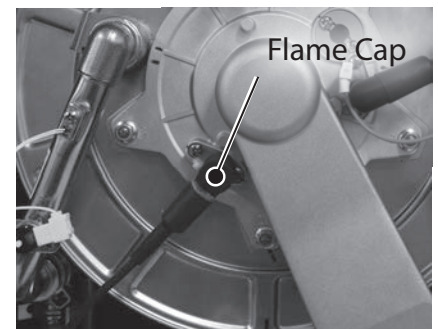

Figure 73 - Remove flame sensor cap

- 6 Use a Phillips screwdriver to remove the two (2) screws securing flame sensor to the burner assembly as shown in Figure 74. Place screws aside in a safe place for reinstallation.

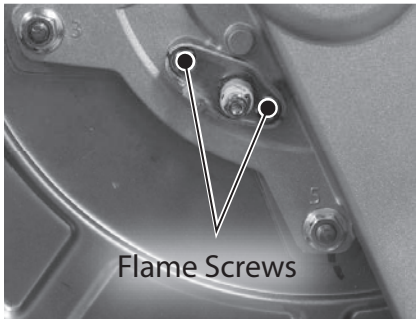

Figure 74 - Remove flame sensor screws

- 7 Remove flame sensor and graphite gasket from burner assembly and dispose of properly.

Installing New Flame Sensor Assembly

- 8 Locate the new flame sensor assembly and graphite gasket provided in the kit. Orient the graphite gasket as shown in Figure 75 and install to flame sensor assembly.

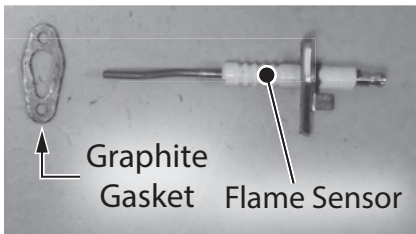

Figure 75 - Install flame sensor and graphite gasket

- 9 Install the flame sensor and graphite gasket to the burner assembly. Secure the flame sensor assembly with the two (2) screws previously removed in **Step 6**. Confirm bracket and graphite gasket sit flush against burner assembly.
- 10 Locate the cap previously removed in **Step 5**. Push the cap back on to the flame sensor assembly. The cap will snap into place when firmly secured to the flame sensor assembly.

Checking for Gas Leaks

- 11 Turn **ON** the gas supply to the water heater at the manual gas shut off valve. Restore power to the water heater. Open all hot water fixtures in the house. This will initiate the call for heat at the water heater.
- 12 Use code approved methods to check for leaks around all gas connection points and the burner door assembly. To protect graphite gaskets from water damage, **DO NOT** perform a bubble test. If any leaks are detected, resecure components and recheck for leaks.

Returning Water Heater to Operation

- 13 Replace the cabinet cover and secure with the screws previously removed in **Step 3**. The water heater is now ready for operation.

SERVICE

IGNITOR ROD ASSEMBLY REPLACEMENT KIT INSTRUCTIONS

Kit 100371182 Contains:

- Ignitor Rod Assembly
- Graphite Gasket
- Kit Instructions

IMPORTANT: Use only factory authorized replacement parts. **DO NOT USE ELECTRIC SCREWDRIVERS OR DRILLS, HAND TIGHTEN ALL SCREWS TO PREVENT OVER TIGHTENING.** If you lack the necessary skills to properly perform the installation, you should not proceed, but get help from a qualified service technician.

Tools and Materials Required:

- Phillips Screwdriver
- Safety Gloves

WARNING!

This kit shall be installed by a qualified service agency in accordance with the manufacturer's instructions and all applicable codes and requirements of the authority having jurisdiction. The information in these instructions must be followed to minimize the risk of fire or explosion or to prevent property damage, personal injury or death. The qualified service agency is responsible for the proper installation of this kit.

Preparing Water Heater for Service

- 1 Disconnect power to the water heater by unplugging it or by turning off the circuit at the breaker box, as appropriate. The power button on the water heater

and remote **DOES NOT** disconnect power to the water heater. You must physically disconnect power to the water heater.

- 2 Shut **OFF** the gas supply to the water heater at the manual gas shut off valve.

Accessing Water Heater Components

- 3 Locate the two (2) screws at the bottom of the cabinet cover. Use a Phillips screwdriver to remove the screws. Place screws aside in a safe place for reinstallation.

- 4 Lift cover up and away from cabinet to gain access to the water heater's internal components.

Removing Ignitor Rod Assembly

- 5 Locate the ignitor rod on the burner assembly as shown in Figure 76. Remove the cap from the ignitor rod. **DO NOT** pull on wires.

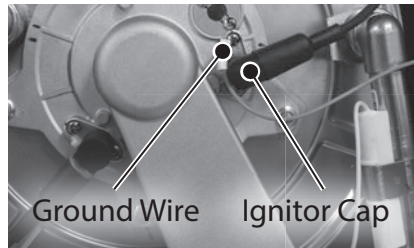

Figure 76 - Remove ignitor rod cap

- 6 Disconnect the green ground wire at the ignitor rod as shown in Figure 76. Route the wire inside the water heater cabinet for ease of access to ignitor rod.

- 7 Use a Phillips screwdriver to remove the two (2) screws securing ignitor rod to the burner assembly. Place screws aside in a safe place for reinstallation.

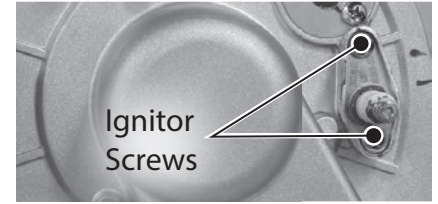

Figure 77 - Remove ignitor rod screws

- 8 Remove ignitor rod and graphite gasket from burner assembly and dispose of properly.

Installing New Ignitor Rod Assembly

- 9 Locate the new ignitor rod assembly and graphite gasket provided in the kit. Orient the graphite gasket as shown in Figure 78 and install to ignitor rod assembly.

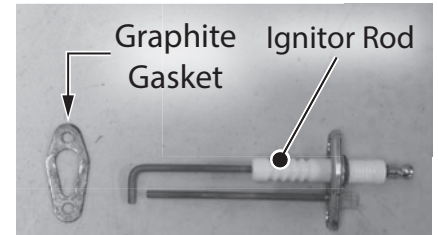

Figure 78 - Install ignitor rod and graphite gasket

- 10 Install the ignitor rod and graphite gasket to the burner assembly. Secure the ignitor rod assembly with the two (2) screws previously removed in **Step 7**. Confirm bracket and graphite gasket sit flush against burner assembly.

- 11 Reconnect the green ground wire previously disconnected in **Step 6**.

NOTICE: Verify rubber casing is fully covering the ground terminal connection at the ignitor rod.

- 12 Locate the cap previously removed in **Step 5**. Push the cap back on to the ignitor rod assembly. The cap will snap into place when firmly secured to the ignitor rod assembly.

Checking for Gas Leaks

13 Turn **ON** the gas supply to the water heater at the manual gas shut off valve. Restore power to the water heater. Open all hot water fixtures in the house. This will initiate the call for heat at the water heater.

14 Use code approved methods to check for leaks around all gas connection points and the burner door assembly. To protect graphite gaskets from water damage, **DO NOT** perform a bubble test. If any leaks are detected, resecure components and recheck for leaks.

Returning Water Heater to Operation

15 Replace the cabinet cover and secure with the screws previously removed in **Step 3**. The water heater is now ready for operation.

SERVICE

IGNITOR ASSEMBLY REPLACEMENT KIT INSTRUCTIONS

Kit 100371181 Contains:

- Ignitor Assembly
- Kit Instructions

IMPORTANT: Use only factory authorized replacement parts. **DO NOT USE ELECTRIC SCREWDRIVERS OR DRILLS, HAND TIGHTEN ALL SCREWS TO PREVENT OVERTIGHTENING.** If you lack the necessary skills to properly perform the installation, you should not proceed, but get help from a qualified service technician.

Tools and Materials Required:

- Phillips Screwdriver
- Safety Gloves

Preparing Water Heater for Service

1 Disconnect power to the water heater by unplugging it or by turning off the circuit at the breaker box, as appropriate. The power button on the water heater and remote **DOES NOT** disconnect power to the water heater. You must physically disconnect power to the water heater.

2 Locate the two screws at the bottom of the cabinet cover. Use a Phillips screwdriver to remove the screws. Place screws aside in a safe place for reinstallation.

3 Lift cover up and away from cabinet to gain access to the water heater's internal components.

Removing the Ignitor Assembly

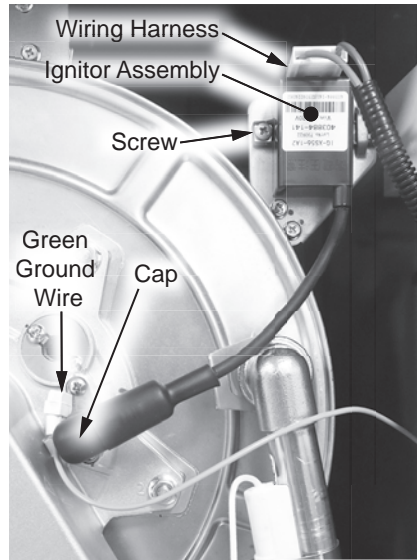

Figure 79 - Ignitor assembly location

- 4** Locate the ignitor assembly on upper right side of the water heater. See Figure 79.
- 5** Disconnect the cap from the ignitor rod. See Figure 79.
- 6** Disconnect the wiring harness from the ignitor assembly. See Figure 79.
- 7** Remove and keep the screw securing the ignitor assembly to the water heater. See

Figure 1.

8 Carefully pull the old ignitor assembly from the water heater and dispose of it properly.

Replacing the Ignitor Assembly

- 9** Locate the ignitor assembly provided in the kit.
- 10** Mount the new ignitor assembly using the screw removed in **Step 7**.
- 11** Reconnect the wiring harness removed in **Step 6**.

12 Reconnect the cap removed in **Step 5**.

Returning Water Heater to Operation

13 Replace the cabinet cover and secure with the screws previously removed in **Step 2**.

14 Restore power to the water heater. The water heater is now ready for operation.

GAS VALVE REPLACEMENT KIT INSTRUCTIONS

Kit 100371174 Contains:

- Gas Valve 100371028
- 3 Gas Valve O-rings (20 x 2.65 NBR)
- Kit Instructions

IMPORTANT: Use only factory authorized replacement parts. **DO NOT USE ELECTRIC SCREWDRIVERS OR DRILLS, HAND TIGHTEN ALL SCREWS TO PREVENT OVERTIGHTENING.** If you lack the necessary skills to properly perform the installation, you should not proceed, but get help from a qualified service technician.

Tools and Materials Required:

- 12" Phillips Screwdriver (Magnetized)
- Safety Gloves

WARNING!
This kit shall be installed by a qualified service agency in accordance with the manufacturer's instructions and all applicable codes and requirements of the authority having jurisdiction. The information in these instructions must be followed to minimize the risk of fire or explosion or to prevent property damage, personal injury or death. The qualified service agency is responsible for the proper installation of this kit.

Preparing Water Heater for Service

- 1 Disconnect power to the water heater by unplugging it or by turning off the circuit at the breaker box, as appropriate. The power button on the water heater and remote **DOES NOT** disconnect power to the water heater. You must physically disconnect power to the water heater.
- 2 Shut **OFF** the gas supply to the water heater at the manual gas shut off valve.
- 3 Locate the two screws at the bottom of the cabinet cover. Use a Phillips screwdriver to remove the screws. Place screws aside in a safe place for reinstallation.
- 4 Lift cover up and away from cabinet to gain access to the water heater's internal components.

Removing the Gas Valve

- 5 Locate the screw securing the control board panel. Use a Phillips screwdriver to remove the screw and place it aside in a safe place for reinstallation. See Figure 80.

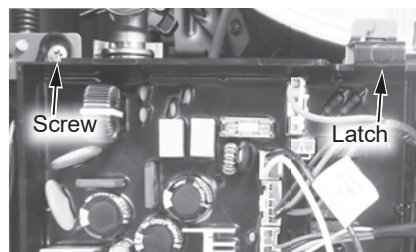

Figure 80 - Control board location

- 6 Press the latch at the top of the circuit board panel and pull the assembly forward from the top. It is hinged at the bottom and can be lowered. The circuit board assembly will hold itself in place.

- 7 Locate the gas valve at the bottom left side of the water heater. See Figure 81.

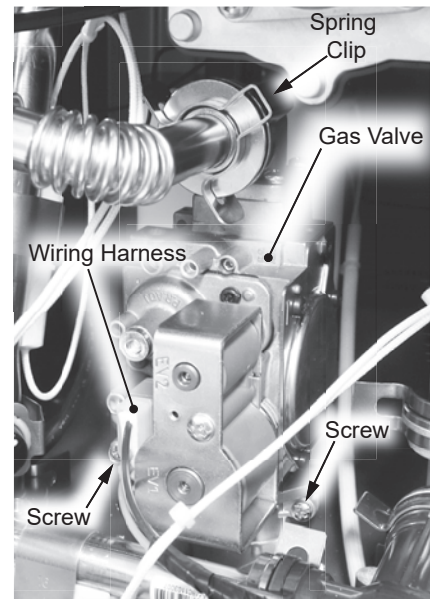

Figure 81 - Gas valve location and connections

- 8 Remove and keep the screw securing the wiring harness to the gas valve. See Figure 81.
- 9 Locate and remove the spring clip securing the gas valve to the gas piping system. Note its orientation and place it aside for reinstallation. See Figure 81.
- 10 Remove and keep the screw at base of the gas valve. See Figure 81.
- 11 Remove the old gas valve and dispose of properly.

Replacing the Gas Valve

- 12 Locate the new gas valve o-ring, install it as shown in Figure 82.

SERVICE

NOTICE: Handle with care and verify lubricant has been applied to o-ring and o-ring is not dirty or damaged.

- 13 Carefully install the new gas valve to the gas connector. Secure with the screw removed in **Step 10**.

NOTICE: Check the fittings for any dirt or debris before making the connection.

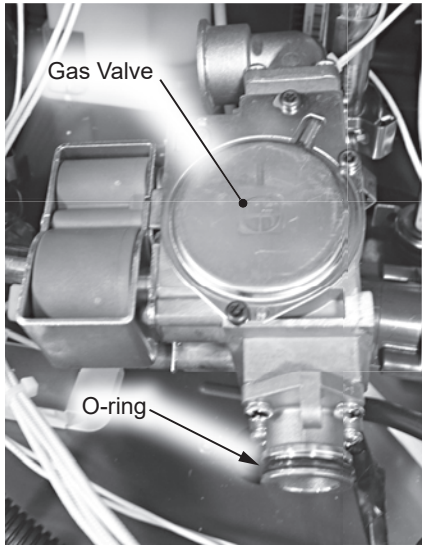

Figure 82 - O-ring replacement (one o-ring)

- 14 Install the two new O-rings on the gas tube as shown in Figure 83.

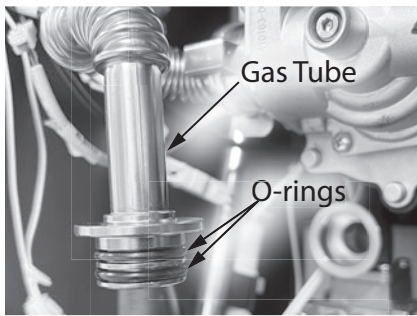

Figure 83 - O-ring replacement (two o-rings)

- 15 Locate the spring clip previously removed in **Step 9**. Install spring clip to gas valve securing it to gas piping system.

- 16 Reinstall the wiring harness and secure with screw removed in **Step 8**.
- 17 Turn **ON** the gas supply to the water heater at the manual gas shut off valve.
- 18 Restore power to the water heater.
- 19 Open all hot water fixtures in the house. This will initiate the call for heat at the water heater.
- 20 Check for leaks around the bottom gas valve connection only. Use a small, soft-bristled brush to apply a hand dishwashing soap and water mixture (1 part soap to 15 parts water) or children's soap bubbles around the bottom gas valve connection. If any leaks are detected (which will appear as small bubbles), resecure the connection and recheck for leaks.

NOTICE: DO NOT apply liquids to the top connection of the gas valve.

- 21 Close all hot water fixtures in the house once the check is complete.

Returning Water Heater to Operation

- 22 Lift the circuit board panel up and lock into place. Install and tighten the screw previously removed in **Step 5**.
- 23 Replace the cabinet cover and secure with the screws previously removed in **Step 3**.
- 24 The water heater is now ready for operation.

FAN ASSEMBLY REPLACEMENT KIT INSTRUCTIONS

Kit 100371169 Contains:

- Fan Assembly
- Fan Inlet O-ring
- Fan Outlet Gasket
- Kit Instructions

IMPORTANT: Use only factory authorized replacement parts. **DO NOT USE ELECTRIC SCREWDRIVERS OR DRILLS, HAND TIGHTEN ALL SCREWS TO PREVENT OVER TIGHTENING.** If you lack the necessary skills to properly perform the installation, you should not proceed, but get help from a qualified service technician.

Tools and Materials Required:

- Phillips Screwdriver
- Marker
- Safety Gloves

Preparing Water Heater for Service

1 Disconnect power to the water heater by unplugging it or by turning off the circuit at the breaker box, as appropriate. The power button on the water heater and remote **DOES NOT** disconnect power to the water heater. You must physically disconnect power to the water heater.

2 Shut **OFF** the gas supply to the water heater at the manual gas shut off valve.

Accessing Water Heater Components

3 Locate the two (2) screws at the bottom of the cabinet cover. Use a Phillips screwdriver to remove the screws. Place screws aside in a safe place for reinstallation.

4 Lift cover up and away from cabinet to gain access to the water heater's internal components.

5 Locate the fan wiring harness on the control board panel as shown in Figure 84. Disconnect and route the wiring out of the way for ease of removing the fan assembly.



Figure 84 - Locate fan wiring harness on control board

6 Locate the screw securing the control board panel as shown in Figure 85. Use a Phillips screwdriver to remove the screw and place it aside in a safe place for reinstallation.

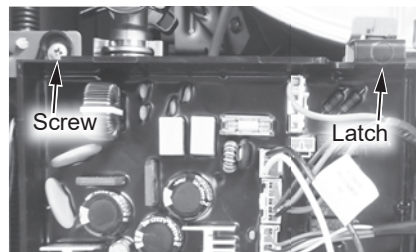

Figure 85 - Control board location

7 Press the latch at the top of the control board panel and pull the assembly forward from the top. It is hinged at the

bottom and can be lowered. The control board assembly will hold itself in place.

Removing Fan & Venturi Assembly

8 Locate the venturi wires (2x) and disconnect them as shown in Figure 86. Wires are labeled "Venturi" and "Micro Switch." These wires are connected at and run through the black cable conduit located on the left side of the water heater cabinet.

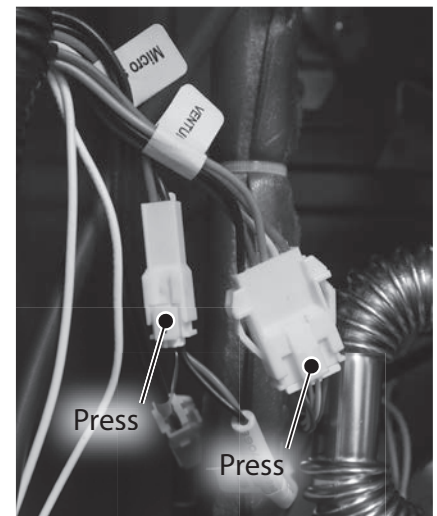

Figure 86 - Locate venturi wire harnesses

9 Locate the gas tube connecting the venturi assembly to the gas valve as shown in Figure 87. Note the orientation of the spring clip securing the gas tube to the gas valve. Remove spring clip and place it aside in a safe place for reinstallation.

SERVICE

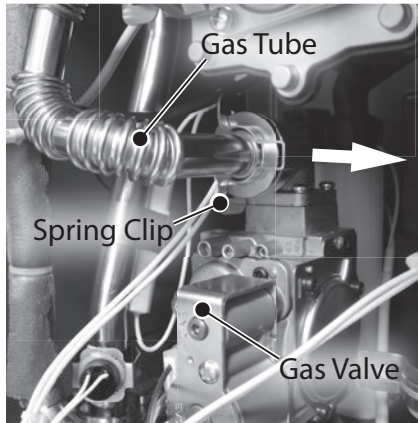

Figure 87 - Remove gas tube spring clip

10 Locate the four (4) screws securing the fan assembly to the burner assembly as shown in Figure 88. Use a Phillips screwdriver to remove the screws. Place the screws aside in a safe place for reinstallation.

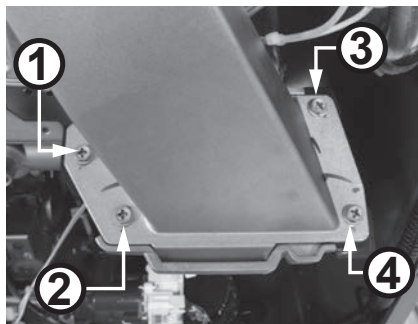

Figure 88 - Remove fan assembly screws

11 Disconnect the gas tube from the gas valve and carefully remove the fan and venturi assembly from the water heater.

Preparing New Fan Assembly

12 Locate the large four screws securing the fan to the venturi. Figure 89 shows venturi facing upright for ease of removing screws.

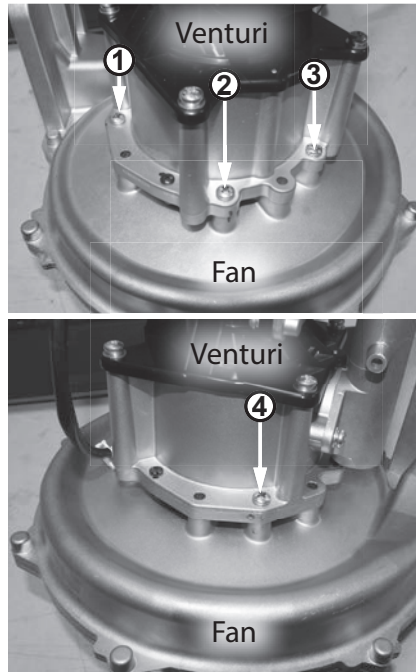

Figure 89 - Locate fan and venturi screws

13 Use a marker to identify the location of each screw hole (4x) on both the fan and venturi. Mark one screw hole location with an orientation mark on the fan and venturi. These marks will assist in proper orientation and installation of the new fan to the venturi.

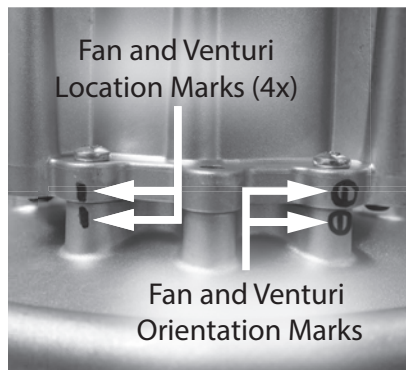

Figure 90 - Screw hole and orientation markings

14 Remove the four (4) screws and separate the venturi assembly from the old fan. Set the old fan aside as an orientation reference.

15 Locate the new fan, outlet gasket, and inlet O-ring provided in kit. Install outlet gasket and inlet O-ring to fan (see Figure 91). Once installed, make sure the outlet gasket and inlet O-ring are fully seated and not damaged.

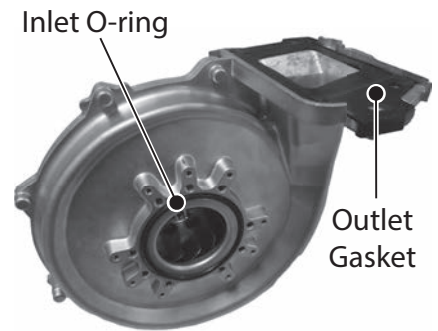

Figure 91 - Install inlet O-ring and outlet gasket to new fan assembly

NOTICE: Handle with care and verify lubricant has been applied to O-rings and O-rings are not dirty or damaged.

16 Install the new fan to the venturi. Reference the orientation mark on the old fan to position the new fan properly as shown in Figure 92. Use the screw hole marks on the venturi to properly install the four (4) screws previously removed in **Step 14**.

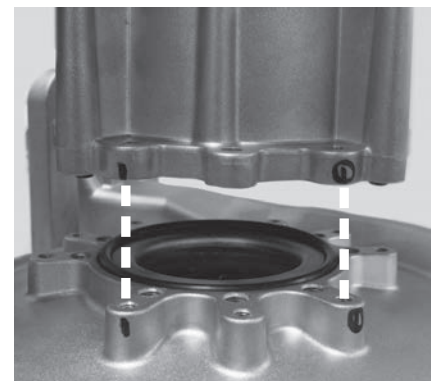

Figure 92 - Proper fan and venturi alignment

Installing Fan & Venturi Assembly

- 17** Fit the fan and venturi assembly to the burner assembly.

NOTICE: Confirm the burner tab engages the fan slot as shown in Figure 93.

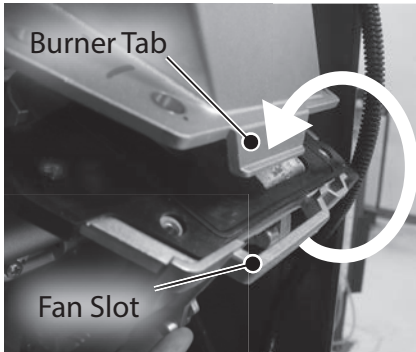

Figure 93 - Burner tab and fan slot

- 18** Locate the four (4) screws previously removed in **Step 10**. Use screws to secure fan and venturi assembly to burner assembly.
- 19** Connect the gas tube to the gas valve. Locate the spring clip previously removed in **Step 9**. Orient spring clip properly as shown in Figure 94. Install spring clip to secure the gas tube to the gas valve. Confirm gas connection is tight and will not leak.

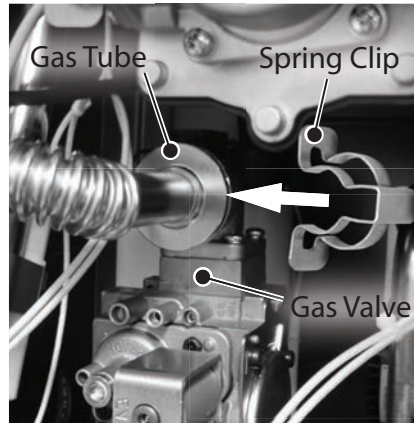

Figure 94 - Secure gas tube with spring clip

- 20** Reconnect the venturi wires (2x) previously disconnected in

Step 8. Confirm connections are secure.

Returning Water Heater to Operation

- 21** Lift the control board panel up and lock into place.
- 22** Install and tighten the screw to the control board panel previously removed in **Step 6**.
- 23** Reconnect the fan wiring harness to the control board panel previously disconnected in **Step 5**.
- 24** Replace the cabinet cover and secure with the screws previously removed in **Step 3**.
- 25** Turn **ON** the gas supply to the water heater at the manual gas shut off valve.
- 26** Restore power to the water heater.

SERVICE

VENTURI & GAS TUBE REPLACEMENT KIT INSTRUCTIONS

Kit 100371205 Contains:

- Venturi Assembly
- (2x) O-ring (20 x 2.65)
- Fan Inlet O-ring
- Fan Outlet Gasket
- Kit Instructions

Kit 100371206 Contains:

- Venturi Assembly
- (2x) O-ring (20 x 2.65)
- Fan Inlet O-ring
- Fan Outlet Gasket
- LP Conversion Kit
- Kit Instructions

Kit 100371173 Contains:

- Gas Tube
- (4x) O-ring (20 x 2.65)
- Kit Instructions

IMPORTANT: Use only factory authorized replacement parts. **DO NOT USE ELECTRIC SCREWDRIVERS OR DRILLS, HAND TIGHTEN ALL SCREWS TO PREVENT OVER TIGHTENING.** If you lack the necessary skills to properly perform the installation, you should not proceed, but get help from a qualified service technician.

Tools and Materials Required:

- Phillips Screwdriver
- Safety Gloves
- Marker

Preparing Water Heater for Service

1 Disconnect power to the water heater by unplugging it or by turning off the circuit at the breaker box, as appropriate. The power button on the water heater and remote **DOES NOT** disconnect power to the water heater. You must physically disconnect power to the water heater.

2 Shut **OFF** the gas supply to the water heater at the manual gas shut off valve.

Accessing Water Heater Components

3 Locate the two (2) screws at the bottom of the cabinet cover. Use a Phillips screwdriver to remove the screws. Place screws aside in a safe place for reinstallation.

4 Lift cover up and away from cabinet to gain access to the water heater's internal components.

5 Locate the fan wiring harness on the control board panel as shown in Figure 95. Disconnect and route the wiring out of the way for ease of removing the fan assembly.



Figure 95 - Locate fan wiring harness on control board

6 Locate the screw securing the control board panel as shown in Figure 96. Use a Phillips screwdriver to remove the screw and place it aside in a safe place for reinstallation.

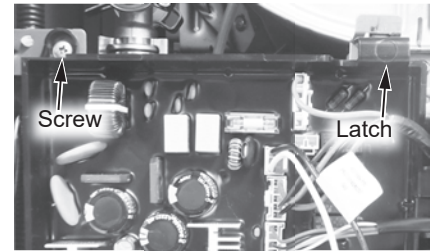

Figure 96 - Control board location

7 Press the latch at the top of the control board panel and pull the assembly forward from the top. It is hinged at the bottom and can be lowered. The control board assembly will hold itself in place.

Removing Venturi & Fan Assembly

8 Locate the gas tube connecting the venturi assembly to the gas valve as shown in Figure 97. Note the orientation of the lower spring clip securing the gas tube to the gas valve. Remove spring clip and place it aside in a safe place for reinstallation.

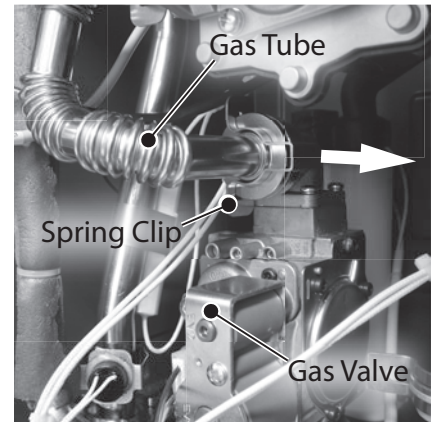

Figure 97 - Remove lower spring clip

9 Locate the upper spring clip securing the gas tube to the venturi as shown in Figure 98. Note the orientation of the upper spring clip securing the gas tube to the venturi. Remove spring clip and place it aside in a safe place for

reinstallation.

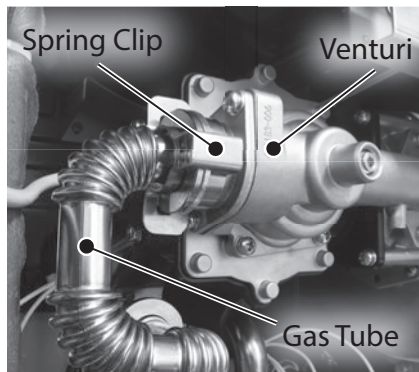

Figure 98 - Remove upper spring clip

Proceed to **Step 10** if not replacing gas tube.

(For Kit 100371173 Only)

- Remove gas tube from venturi and gas valve. Dispose of gas tube properly.
- Locate the new gas tube and four (4) O-rings provided in the kit. Install O-rings to grooves located on each end of gas tube as shown in Figure 99. Install gas tube to venturi and gas valve.

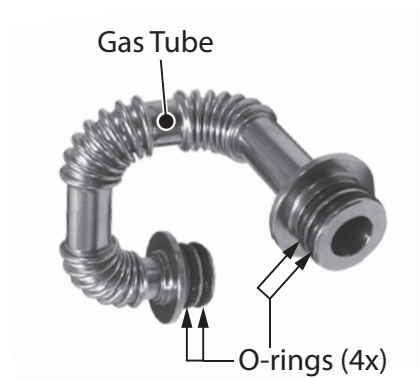

Figure 99 - Install O-rings to gas tube

NOTICE: Handle with care and verify lubricant has been applied to O-rings and O-rings are not dirty or damaged.

- Locate the two spring clips previously removed. Orient spring clips properly as shown in Figure 100 &

Figure 101. Install spring clips to secure the gas tube to the venturi and gas valve. Confirm gas connections are tight and will not leak.

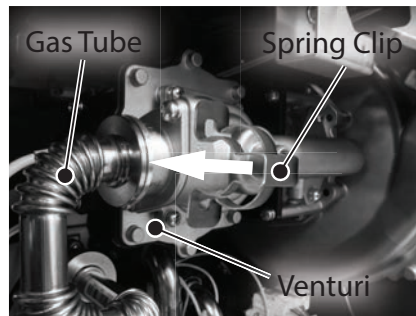

Figure 100 - Secure upper spring clip

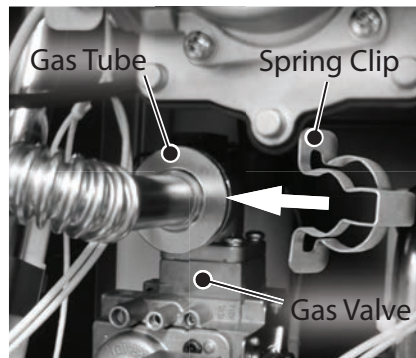

Figure 101 - Secure lower spring clip

- Proceed to **Step 25** if not replacing venturi assembly.
- 10** Locate the venturi wires (2x) and disconnect them as shown in Figure 102. Wires are labeled "Venturi" and "Micro Switch." These wires are connected at and run through the black cable conduit located on the left side of the water heater cabinet.

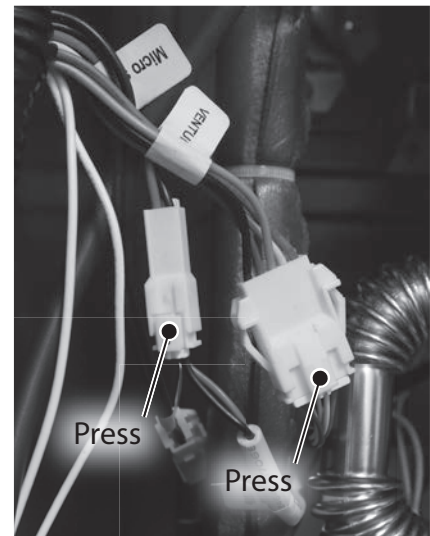

Figure 102 - Locate venturi wire harnesses

- 11** Locate the four (4) screws securing the fan assembly to the burner assembly as shown in Figure 103. Use a Phillips screwdriver to remove the screws. Place the screws aside in a safe place for reinstallation.

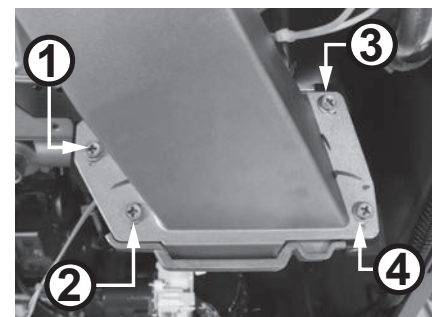

Figure 103 - Remove fan assembly screws

- 12** Disconnect the gas tube from the gas valve and carefully remove the venturi and fan assembly from the water heater.

Replacing Venturi Assembly

- 13** Locate the large four screws securing the venturi to the fan. Figure 104 shows venturi facing upright for ease of removing screws.

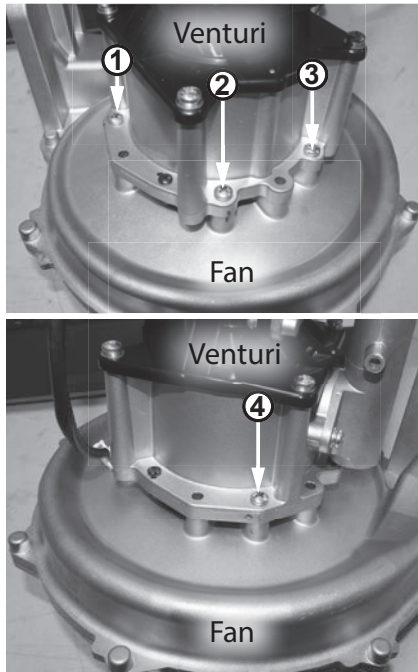

Figure 104 - Locate venturi and fan screws

14 Use a marker to identify the location of each screw hole (4x) on both the venturi and fan. Mark one screw hole location with an orientation mark on the venturi and fan. These marks will assist in proper orientation and installation of the new venturi to the fan.

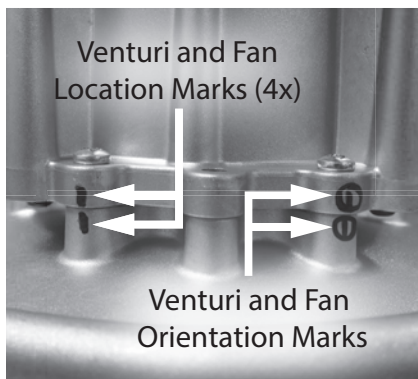

Figure 105 - Screw hole and orientation markings

15 Remove the four (4) screws and separate the venturi assembly from the fan. Set aside the old venturi as an orientation reference.

16 Remove gas tube from venturi. Place gas tube aside in a safe place for reinstallation.

(For Kit 100371206 Only)

- Locate the new venturi provided in the kit. Follow the instructions provided in the kit to convert venturi from natural gas to LP (liquid propane gas). Proceed to the next step.

17 Install the new venturi to the fan. Reference the orientation mark on the old venturi to position the new venturi properly as shown in Figure 106. Use the screw hole marks on the fan to properly install the four (4) screws previously removed in **Step 13**.

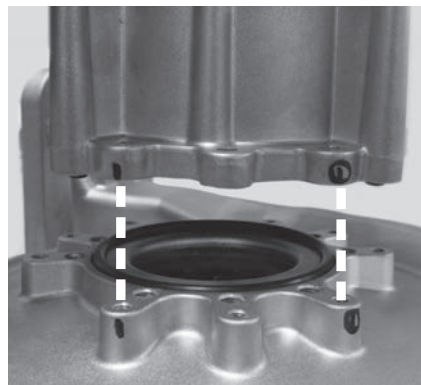

Figure 106 - Proper venturi and fan alignment

18 Dispose of old venturi assembly properly.

19 Locate the two (2) O-rings provided in the kit. Remove the two (2) old O-rings from gas tube (venturi mating side) and install the two (2) new O-rings as shown in Figure 107.

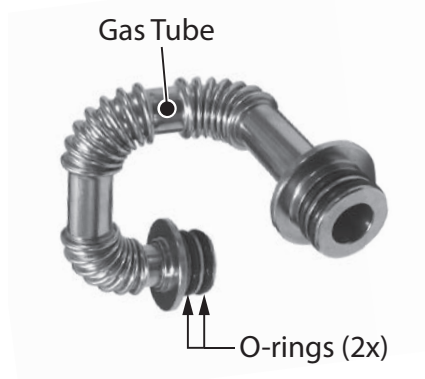

Figure 107 - Install venturi O-rings to gas tube

NOTICE: Handle with care and verify lubricant has been applied to O-rings and O-rings are not dirty or damaged.

20 Install gas tube to venturi and locate spring clip previously removed in **Step 9**. Orient spring clip properly as shown in Figure 98. Install spring clip to secure the gas tube to the venturi. Confirm gas connection is tight and will not leak.

Installing Venturi & Fan Assembly

21 Locate the new fan outlet gasket, and inlet O-ring provided in kit. Install outlet gasket and inlet O-ring to fan (see Figure 108). Once installed, make sure the outlet gasket and inlet O-ring are fully seated and not damaged.

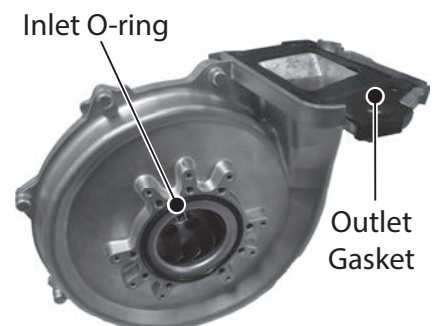

Figure 108 - Install inlet O-ring and outlet gasket to new fan assembly

- 22** Fit the venturi and fan assembly to the burner assembly.

NOTICE: Confirm the burner tab engages the fan slot as shown in Figure 109.

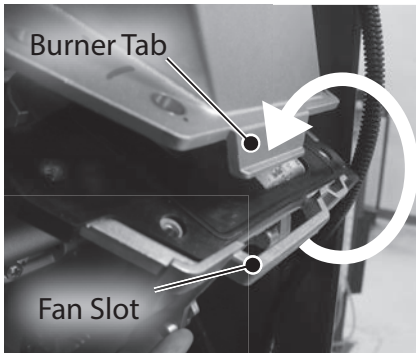

Figure 109 - Burner tab and fan slot

- 23** Locate the four (4) screws previously removed in **Step 11**. Use screws to secure fan and venturi assembly to burner assembly.
- 24** Connect the gas tube to the gas valve. Locate the spring clip previously removed in **Step 8**. Orient spring clip properly as shown in Figure 101. Install spring clip to secure the gas tube to the gas valve. Confirm gas connection is tight and will not leak.
- 25** Reconnect the venturi wires (2x) previously disconnected in **Step 10**. Confirm wire connections are secure.

Returning Water Heater to Operation

- 26** Lift the control board panel up and lock into place.
- 27** Install and tighten the screw to the control board panel previously removed in **Step 6**.

- 28** Reconnect the fan wiring harness to the control board panel previously disconnected in **Step 5**.
- 29** Replace the cabinet cover and secure with the screws previously removed in **Step 3**.
- 30** Turn **ON** the gas supply to the water heater at the manual gas shut off valve.
- 31** Restore power to the water heater.

BURNER REPLACEMENT KIT INSTRUCTIONS

Kit 100371164 Contains:

- Burner
- (2x) Graphite Gasket, Flame & Ignitor Rods, (100371091)
- Graphite Gasket, Burner Door, (100371052)
- Burner Insulation Gasket, 125 mm OD, (100371054)
- Burner Insulation Gasket, 87 mm OD, (100371051)
- Burner Insulation, Inner Vermiculite Ring, (100371103)
- Kit Instructions

IMPORTANT: Use only factory authorized replacement parts. **DO NOT USE ELECTRIC SCREWDRIVERS OR DRILLS, HAND TIGHTEN ALL SCREWS TO PREVENT OVER TIGHTENING.** If you lack the necessary skills to properly perform the installation, you should not proceed, but get help from a qualified service technician.

Tools and Materials Required:

- 12" Phillips Screwdriver (magnetized)
- 10 mm Hex Socket
- Torque Wrench
- Mini Pick or Hook
- Plastic Scraper
- Safety Gloves

Preparing Water Heater for Service

- 1** Disconnect power to the water heater by unplugging it or by turning off the circuit at the breaker box, as appropriate. The power button on the water heater and remote **DOES NOT** disconnect power to the water heater. You must physically disconnect power to the water heater.

SERVICE

- 2 Shut **OFF** the gas supply to the water heater at the manual gas shut off valve.

Accessing Water Heater Components

- 3 Locate the two (2) screws at the bottom of the cabinet cover. Use a Phillips screwdriver to remove the screws. Place screws aside in a safe place for reinstallation.

- 4 Lift cover up and away from cabinet to gain access to the water heater's internal components.

- 5 Locate the fan wiring harness on the control board panel as shown in Figure 110. Disconnect and route the wiring out of the way for ease of removing the fan and venturi assembly.



Figure 110 - Locate fan wiring harness on control board

- 6 Locate the screw securing the control board panel as shown in Figure 111. Use a Phillips screwdriver to remove the screw and place it aside in a safe place for reinstallation.

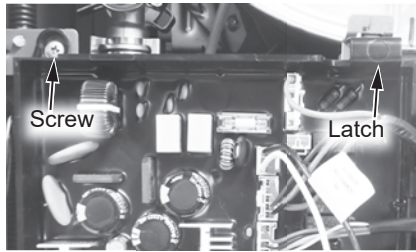

Figure 111 - Control board location

- 7 Press the latch at the top of the control board panel and pull the assembly forward from the top. It is hinged at the bottom and can be lowered. The control board assembly will hold itself in place.

Removing Fan & Venturi Assembly

- 8 Locate the venturi wires (2x) and disconnect them as shown in Figure 112. Wires are labeled "Venturi" and "Micro Switch." These wires are connected at and run through the black cable conduit located on the left side of the water heater cabinet.

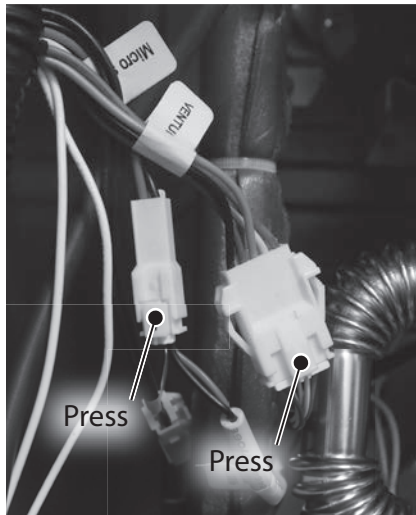

Figure 112 - Locate venturi wire harnesses

- 9 Locate the gas tube connecting the venturi assembly to the gas valve as shown in Figure 13. Note the orientation of the spring clip securing the gas tube to the gas valve. Remove spring clip and place it aside in a safe place for reinstallation.

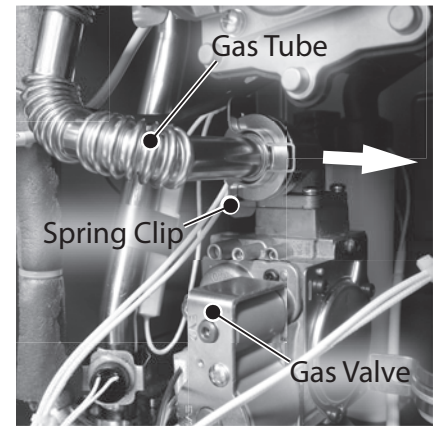

Figure 113 - Remove gas tube spring clip

- 10 Locate the four (4) screws securing the fan assembly to the burner door assembly as shown in Figure 114. Use a Phillips screwdriver to remove the screws. Place the screws aside in a safe place for reinstallation.

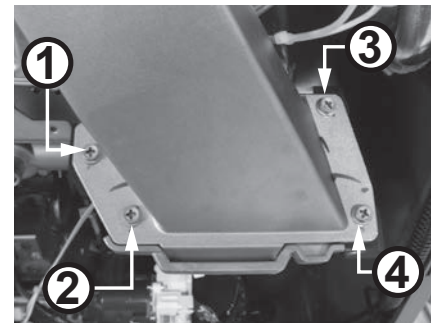

Figure 114 - Remove fan assembly screws

- 11 Disconnect the gas tube from the gas valve and carefully remove the fan and venturi assembly from the water heater.

Removing Flame Sensor & Ignitor Rod Assemblies

12 Locate the flame sensor and ignitor rod on the burner assembly as shown in Figure 115. Remove the caps from the flame sensor and ignitor rod. Disconnect the green ground wire from the ignitor rod.

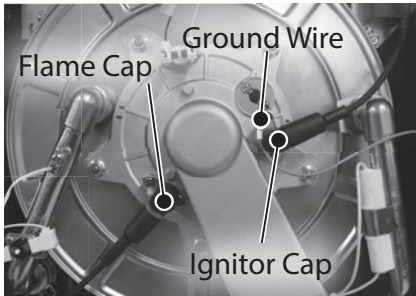

Figure 115 - Remove ignitor rod and flame sensor caps

13 Use a Phillips screwdriver to remove the four (4) screws securing flame sensor and ignitor rod to the burner assembly. Place screws aside in a safe place for reinstallation.



Figure 116 - Remove ignitor rod and flame sensor screws

14 Remove flame sensor, ignitor rod and the two (2) graphite gaskets from burner assembly and place them aside in a safe place for reinstallation.

Disconnect Burner Door Hi-Limit

15 Locate the burner door hi-limit on the burner assembly as shown in Figure 117. Disconnect the two (2) wire leads from the hi-limit assembly and route them inside the water heater cabinet for ease of access to burner door.

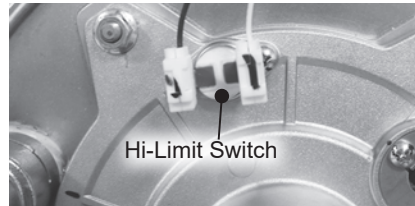

Figure 117 - Burner door hi-limit location

Removing Burner Door Assembly

16 Locate the five (5) hex nuts securing the burner door assembly to the heat exchanger as shown in Figure 118. Use a 10 mm hex socket to remove hex nuts. Place hex nuts aside in a safe location for reinstallation.

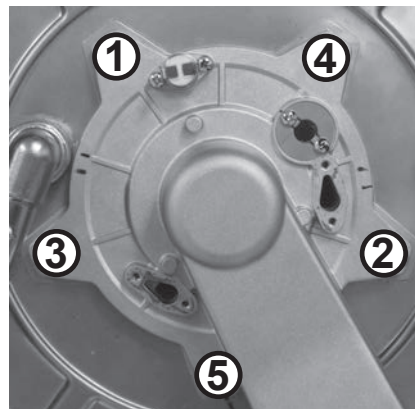

Figure 118 - Remove burner door hex nuts

NOTICE: Star pattern in Figure 118 above **MUST** be followed during reinstallation of screws to burner door assembly.

17 Remove the burner door assembly from the heat exchanger. Carefully pull the assembly out such that the burner and outer vermiculite ring are not damaged as shown in Figure 119.

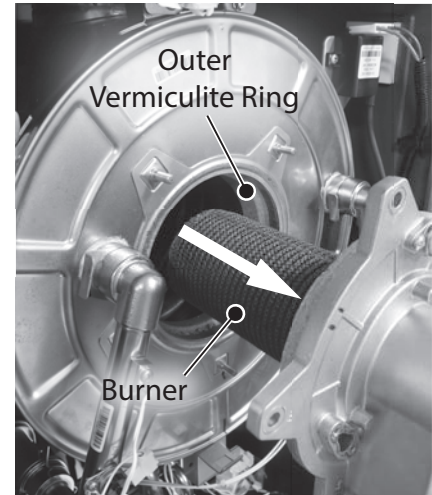

Figure 119 - Remove burner door assembly

Replacing Burner Door Gaskets and Insulation

18 Locate the three (3) screws securing the inner vermiculite insulation ring to the burner door as shown in Figure 120. Use a Phillips screwdriver to remove screws. Place screws aside in a safe place for reinstallation.

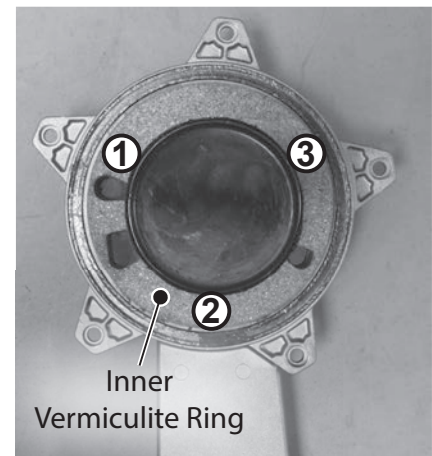

Figure 120 - Remove inner vermiculite ring

SERVICE

19 Slide vermiculite insulation ring over and off burner. Dispose of vermiculite insulation ring properly.

20 Locate the three (3) screws securing the burner to the burner door as shown in Figure 121. Use a Phillips screwdriver to remove screws. Place screws aside in a safe place for reinstallation.

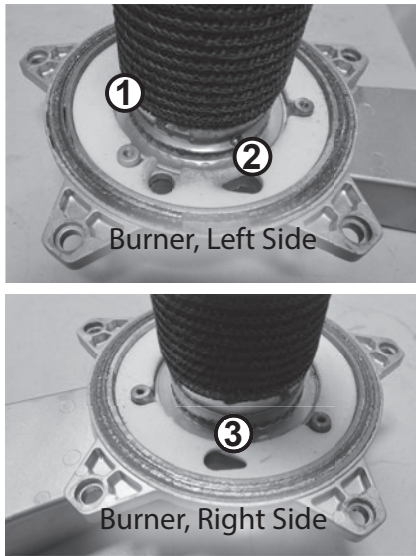

Figure 121 - Remove burner screws

21 Remove the burner from the burner door and dispose of properly.

22 Locate the small and large insulation gaskets on the burner door as shown in Figure 122. Use a plastic scraper to gently scrape insulation clean from burner door. Confirm burner door surfaces are free of any debris or leftover insulation.

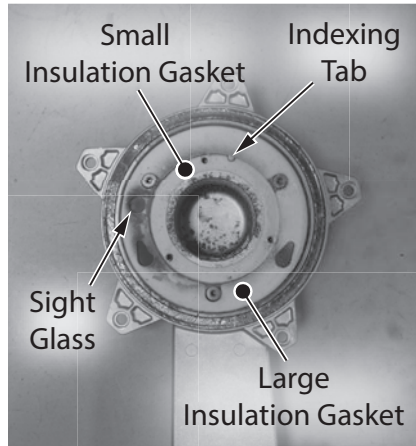

Figure 122 - Burner insulation gaskets

IMPORTANT! DO NOT gouge or damage burner door surfaces when removing insulation gaskets.

23 Locate the new, small insulation gasket (100371051) provided in the kit. Install the small insulation gasket first. Flip gasket so the adhesive side is facing the burner door surface. Note the indexing tab on the burner door to properly orient the gasket (Figure 122). Confirm gasket sits evenly and flush with burner door.

24 Locate the new, large insulation gasket (100371054) provided in the kit. Install the large insulation gasket second. Flip gasket so the adhesive side is facing the burner door surface. Note the location of the sight glass on burner door to properly orient the gasket (Figure 122). Confirm gasket sits evenly and flush with burner door.

25 Locate the graphite gasket on the burner door as shown in Figure 123. Use a mini pick or hook to remove gasket from groove. Dispose of gasket properly.

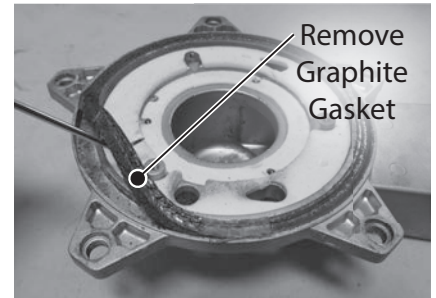

Figure 123 - Remove burner door graphite gasket

26 Locate new graphite gasket (100371052) provided in kit. Orient gasket so side with slight chamfer is facing the groove in the burner door (Figure 124). Carefully install new graphite gasket to groove in burner door. Confirm gasket sits flush in groove.

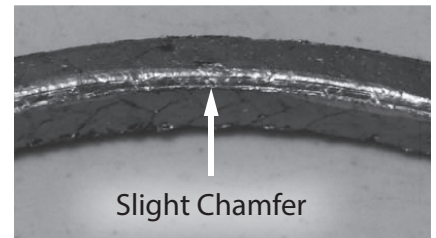

Figure 124 - Properly orient graphite gasket

27 Locate the new burner provided in the kit. Install burner to burner door. Use the indexing tab to properly orient burner as shown in Figure 122. Secure with the three (3) screws previously removed in **Step 20**.

28 Locate the new inner vermiculite insulation ring (100371103) provided in the kit. Orient the ring as shown in Figure 11. The flat side should be facing the groove in burner door. Carefully slide it over burner and secure vermiculite to assembly with the three (3) screws previously removed in **Step 18**.

Installing Burner Door Assembly

29 Install burner door assembly over bolts in heat exchanger. Locate the five (5) hex nuts previously removed in **Step 16**. Hand tighten the hex nuts, then use a 10 mm hex socket to tighten each nut in a star pattern as indicated by the numbers (1-5) adjacent to the bolt holes. Torque hex nuts to 7.4 ft-lbs. (10 Nm). See Figure 118 as reference.

Reconnect Burner Door Hi-Limit

30 Locate the burner door hi-limit and reconnect the two (2) wire leads previously disconnected in **Step 15**.

Installing Flame Sensor & Ignitor Rod Assemblies

31 Remove old graphite gaskets on flame sensor and ignitor rod assemblies and replace with new, small graphite gaskets (100371091) provided in the kit.

32 Follow **Steps 12-14** in reverse order to install flame sensor and ignitor rod assemblies to burner assembly.

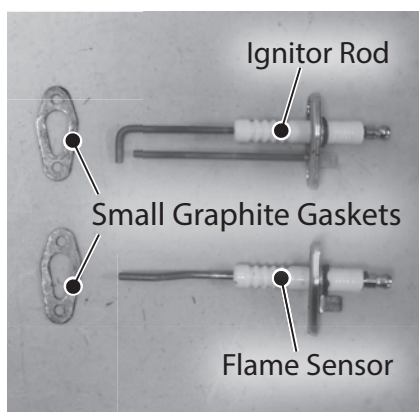

Figure 125 - Replace ignitor rod and flame sensor assemblies

Installing Fan & Venturi Assembly

33 Locate the fan and venturi assembly previously removed from the water heater in **Step 11**. Follow **Steps 8-11** in reverse order to install fan and venturi assembly to water heater.

NOTICE: Confirm the burner assembly tab engages the slot on the fan as shown in Figure 126.

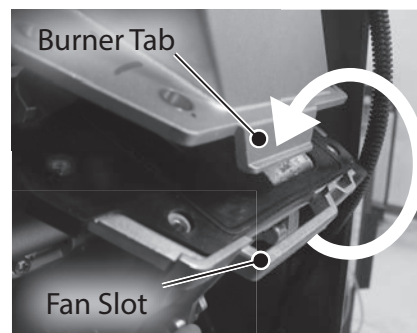

Figure 126 - Burner tab and fan slot

34 Lift the control board panel up and lock into place.

35 Reconnect the fan wiring harness to the control board panel previously disconnected in **Step 5**.

Checking for Gas Leaks

36 Turn **ON** the gas supply to the water heater at the manual gas shut off valve. Restore power to the water heater. Open all hot water fixtures in the house. This will initiate the call for heat at the water heater.

37 Check for leaks around all gas connection points and the burner door assembly. Use a small, soft-bristled brush to apply a hand dishwashing soap and water mixture (1 part soap to 15 parts water) or children's soap bubbles around the burner assembly. If any leaks are

detected (which will appear as small bubbles), resecure components and recheck for leaks.

Returning Water Heater to Operation

38 Install and tighten the screw to the control board panel previously removed in **Step 6**.

39 Replace the cabinet cover and secure with the screws previously removed in **Step 3**.

SERVICE

HEAT EXCHANGER REPLACEMENT KIT INSTRUCTIONS

Kit 100371179 Contains:

- Heat Exchanger (HEX) Assembly (includes flame sensor, ignitor rod, sight glass, exhaust thermistor and burner door hi-limit)
- (2x) O-ring (21.8 x 2.4)
- Exhaust Gasket
- Kit Instructions

IMPORTANT: Use only factory authorized replacement parts. **DO NOT USE ELECTRIC SCREWDRIVERS OR DRILLS, HAND TIGHTEN ALL SCREWS TO PREVENT OVER TIGHTENING.** If you lack the necessary skills to properly perform the installation, you should not proceed, but get help from a qualified service technician.

Tools and Materials Required:

- 12" Phillips Screwdriver (magnetized)
- Flathead Screwdriver
- 8 mm Hex Socket with 8" & 16" extensions
- Towel or Rag
- Bucket
- Safety Gloves

Preparing Water Heater for Service

- 1** Disconnect power to the water heater by unplugging it or by turning off the circuit at the breaker box, as appropriate. The power button on the water heater and remote **DOES NOT** disconnect power to the water heater. You must physically disconnect power to the water heater.
- 2** Shut **OFF** the gas supply to the water heater at the manual gas shut off valve.

- 3** Shut **OFF** the cold water supply to the water heater at the cold inlet valve.
- 4** Open all hot water fixtures in the house. When the residual water flow has ceased, close all hot water fixtures. This will depressurize the water heater.

Draining the Water Heater

- 5** Drain the X3®/Bypass Cartridge. Place a bucket or pan underneath cartridge to collect water during removal.
- 6** Locate the three (3) screws securing the X3®/Bypass cartridge as shown in Figure 127. Remove the **(A)** M4-12mm screw and the two **(B)** M4-25mm screws from cartridge. Place screws aside in a safe place for reinstallation.

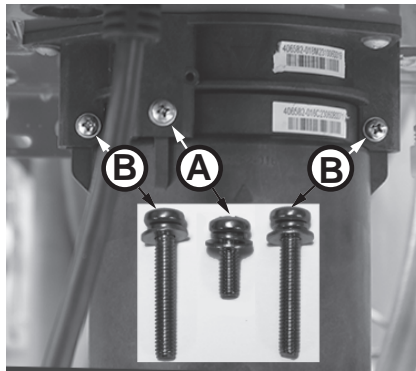

Figure 127 - Identify cartridge screws

- 7** Pull down to remove the cartridge from the water heater. Wait a few minutes to ensure all water has completely drained.
- 8** Locate and remove the inlet filter as shown in Figure 2 to drain any residual water left in the system. Place a bucket or pan underneath inlet filter to collect water during removal.

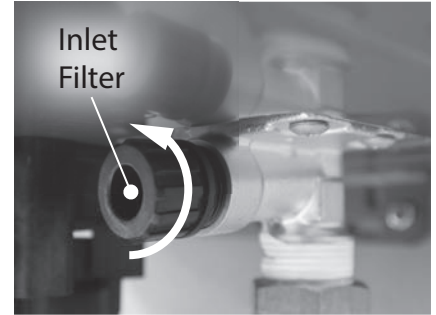

Figure 128 - Removing the inlet filter

- 9** Once the water heater has been adequately drained, reinstall inlet filter to water heater and tighten by hand. Confirm inlet filter is secured to water heater.
- 10** Reinstall the cartridge to the water heater. Locate the screws previously removed in **Step 6**. Insert and snug all three (3) screws by hand.

NOTICE: The X3® cartridge is keyed to only install in one direction. Align the ▲ on the cartridge with the ▼ on the manifold. When inserting the cartridge, push up until the screw holes align. Some resistance is normal. The bypass cartridge is not keyed and will install in either direction.

- 11** Use a screwdriver to tighten the two **(B)** screws first and lastly tighten screw **(A)**. **DO NOT** use a drill or impact driver to tighten the screws.

Accessing Water Heater Components

- 12** Locate the two (2) screws at the bottom of the cabinet cover. Use a Phillips screwdriver to remove the screws. Place screws aside in a safe place for reinstallation.
- 13** Lift cover up and away from cabinet to gain access to the water heater's internal components.

- 14** Locate the fan wiring harness on the control board panel as shown in Figure 129.

Disconnect and route the wiring out of the way for ease of removing the fan and venturi assembly.



Figure 129 - Locate fan wiring harness on control board

- 15** Locate the screw securing the control board panel as shown in Figure 128. Use a Phillips screwdriver to remove the screw and place it aside in a safe place for reinstallation.

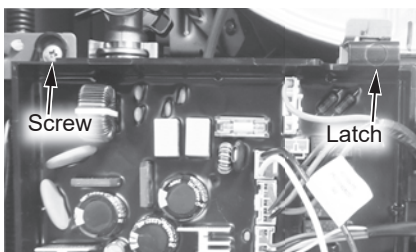

Figure 130 - Control board location

- 16** Press the latch at the top of the control board panel and pull the assembly forward from the top. It is hinged at the bottom and can be lowered. The control board assembly will hold itself in place.

Removing Fan & Venturi Assembly

- 17** Locate the wire connectors labeled "Venturi" and "Micro Switch" and disconnect them as shown in Figure 131. These wires are connected at and run through the black cable conduit located on the left side of the water heater cabinet.

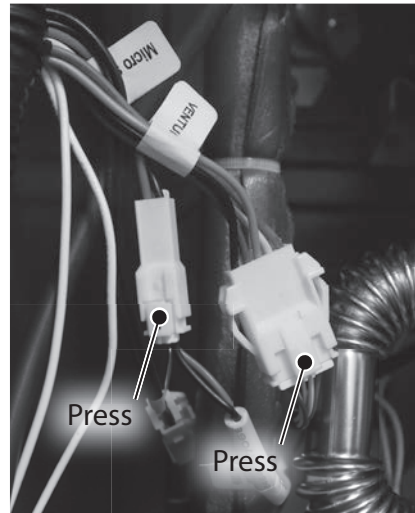

Figure 131 - Locate venturi and micro switch wires

- 18** Locate the gas tube connecting the venturi assembly to the gas valve as shown in Figure 132. Note the orientation of the spring clip securing the gas tube to the gas valve. Remove spring clip and place it aside in a safe place for reinstallation. Leave the gas tube connected to gas valve. This will provide support when removing the fan assembly screws.

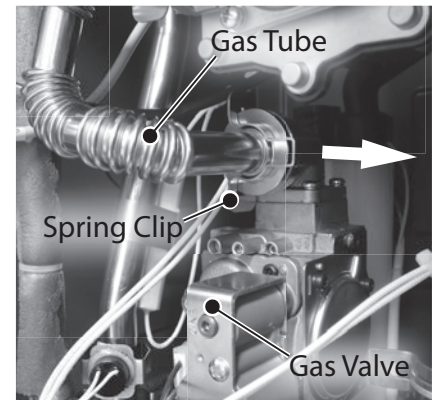

Figure 132 - Remove gas tube spring clip

- 19** Locate the four (4) screws securing the fan assembly to the burner door assembly as shown in Figure 133. Use a Phillips screwdriver to remove the screws. Place the screws aside in a safe place for reinstallation.

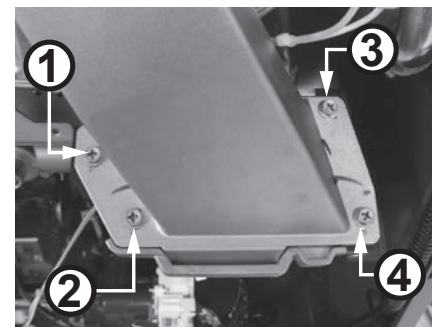

Figure 133 - Remove fan assembly screws

- 20** Disconnect the gas tube from the gas valve and carefully remove the fan and venturi assembly from the water heater.

Disconnecting Condensate Hose

- 21** Disconnect the black hose from the top of the condensate trap and then from the back of the heat exchanger as shown in Figure 134. Compress the spring clamp and pull it down along with the black hose. Place hose aside in a safe place for reinstallation.

SERVICE

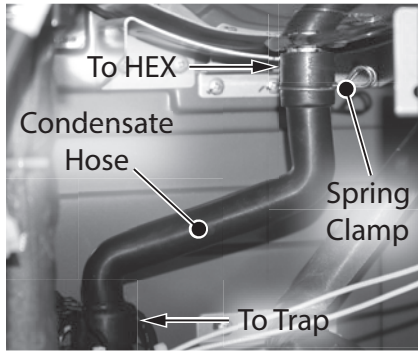

Figure 134 - Disconnect condensate hose

Removing Heater Blocks

22 Locate the two heater blocks attached to the top and bottom of HEX inlet tube as shown in Figure 135. Remove brackets (size 20) securing heater blocks to tube. Place brackets aside in a safe place for reinstallation. Route heater blocks and wiring inside water heater cabinet for ease of access to heat exchanger.

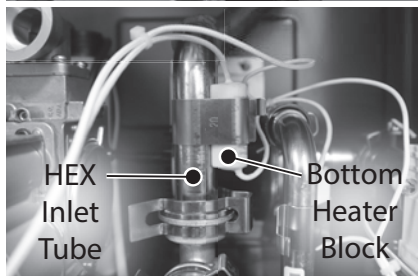
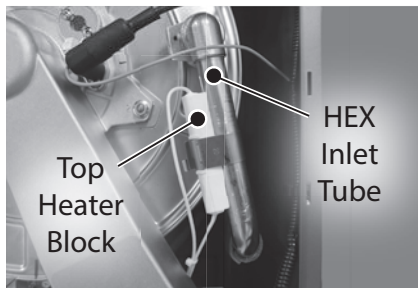

Figure 135 - Remove heater blocks from HEX inlet tube

Removing HEX Inlet Tube

23 Locate the HEX inlet tube as shown in Figure 136. Remove the spring clip (size 30) securing the HEX inlet tube to the

outlet tee. Place bracket aside in a safe place for reinstallation.

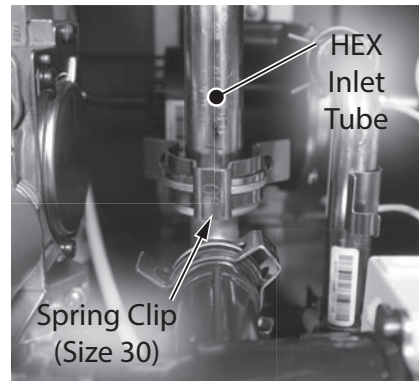

Figure 136 - Remove spring clip securing HEX inlet tube

24 Locate the fastener securing the HEX inlet tube to the heat exchanger as shown in Figure 137. Use a flathead screwdriver to gently pry the fastener free. Remove fastener and place it aside in a safe place for reinstallation.

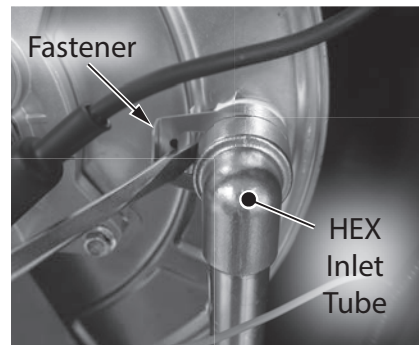

Figure 137 - Remove fastener securing HEX inlet tube

25 Disconnect HEX inlet tube from heat exchanger and outlet tee. Remove HEX inlet tube from water heater and place it aside in a safe place for reinstallation.

Removing HEX Outlet Tube

26 Locate the HEX outlet tube as shown in Figure 138. Remove the spring clip (size 30) securing the HEX outlet tube to the mixing tee. Place bracket aside in a safe place for reinstallation.

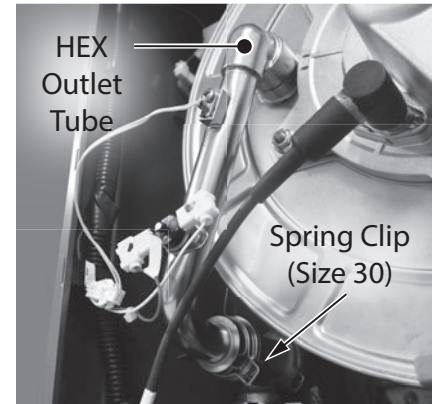

Figure 138 - Remove spring clip securing HEX outlet tube

27 Locate the fastener securing the HEX outlet tube to the heat exchanger as shown in Figure 139. Use a flathead screwdriver to gently pry the fastener free. Remove fastener and place it aside in a safe place for reinstallation.

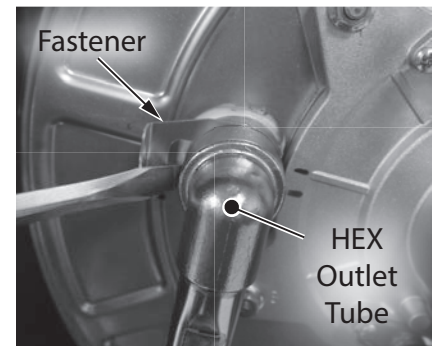

Figure 139 - Remove fastener securing HEX outlet tube

28 Locate the hi-limit switch and thermostat wiring connected to the HEX outlet tube as shown in Figure 140. Disconnect the hi-limit wires (labeled "HI LIMIT 2") from the switch. Disconnect the thermostat wiring (labeled "HEX") by pressing on the small tab while separating the wires.

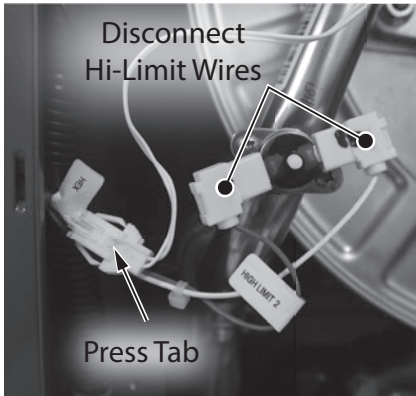

Figure 140 - Disconnect HEX outlet tube wiring

- 29 Disconnect HEX outlet tube from heat exchanger and mixing tee and place it aside in a safe place for reinstallation.

Disconnecting Flame Sensor & Ignitor Rod Caps

- 30 Locate the flame sensor and ignitor rod on the burner assembly as shown in Figure 141 (following page). Remove the caps from flame sensor and ignitor rod. **DO NOT** pull wires. Disconnect the green ground wire from the ignitor rod assembly.

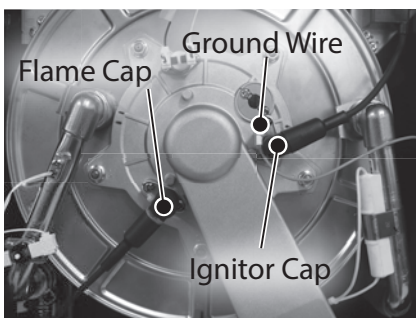

Figure 141 - Remove ignitor rod and flame sensor caps

Removing Ignitor Assembly

- 31 Locate the ignitor assembly on upper right side of the heat exchanger as shown in Figure 142.

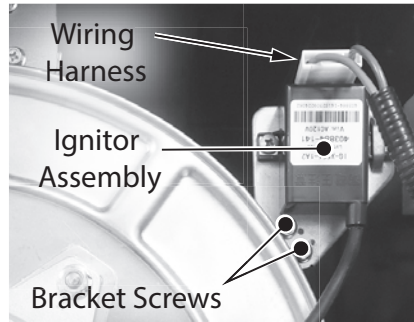

Figure 142 - Ignitor assembly location

- 32 Disconnect the wiring harness from the ignitor assembly.
- 33 Locate the two (2) screws securing ignitor assembly bracket to heat exchanger. Remove screws, bracket and ignitor assembly from heat exchanger. Place components aside in a safe place for reinstallation.

Disconnecting Burner Door Hi-Limit & Exhaust Thermistor

- 34 Locate the burner door hi-limit and exhaust thermistor wiring connected to the heat exchanger as shown in Figure 143. Disconnect the hi-limit wires (labeled "HI LIMIT 1") from terminals. Disconnect the thermistor wiring (labeled "EXHAUST") by pressing on the small tab while separating the wires.

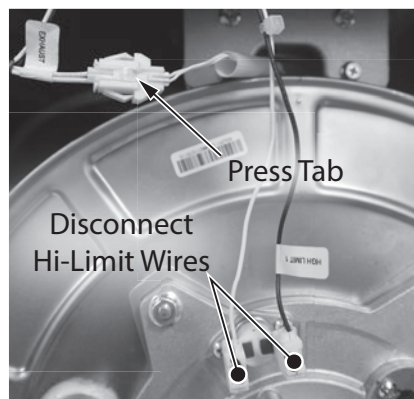

Figure 143 - Disconnect hi-limit and exhaust thermistor wiring

- 35 Route exhaust thermistor wiring through the heat exchanger install bracket for ease of removing heat exchanger.

Removing Pressure Switch Assembly

- 36 Locate the pressure switch assembly on upper left side of the heat exchanger as shown in Figure 144.

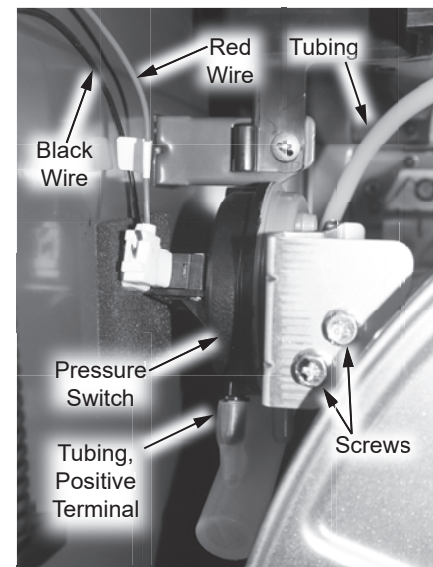

Figure 144 - Pressure switch assembly location

- 37 Disconnect the tubing from heat exchanger.
- 38 Locate the two (2) screws securing pressure switch assembly bracket to heat exchanger. Remove screws, bracket and pressure switch assembly from heat exchanger.
- 39 Disconnect the black wire harness from the common (C) connector and the red wire harness from the normally closed (NC) connector. Place components aside in a safe place for reinstallation.

SERVICE

Removing Heat Exchanger



Lifting Risk

▲ WARNING! The heat exchanger is heavy. Follow these

precautions to reduce the risk of property damage, injuries from lifting or impact injuries from dropping the water heater.

- 40** Locate the two vertical (2) brackets and four (4) screws securing the heat exchanger to the backside of the water heater cabinet as shown in Figure 145.

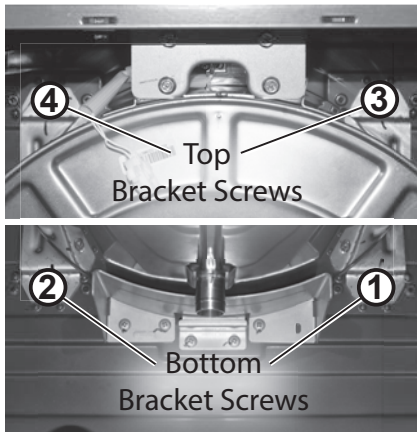

Figure 145 - Locate and remove heat exchanger bracket screws

- 41** Use an 8 mm hex socket with an 8" extension to remove the bottom screw on the right bracket.

- 42** Use an 8 mm hex socket with a 16" extension to remove the bottom screw on the left bracket.

- 43** Use an 8 mm hex socket with a 16" extension to remove the two (2) top screws on each bracket.

Place all four (4) screws aside in a safe place for reinstallation.

- 44** Disconnect exhaust piping from exhaust port. Locate

and remove the four (4) screws securing exhaust port to water heater cabinet as shown in Figure 146. Place screws aside in a safe place for reinstallation.

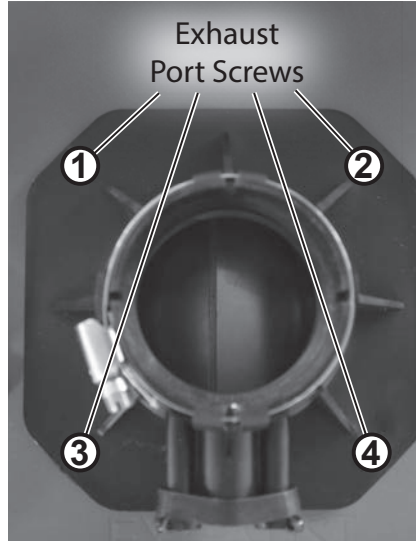

Figure 146 - Remove exhaust port screws

- 45** Disconnect exhaust port from water heater and set aside in a safe place for reinstallation.

- 46** Locate the heat exchanger install bracket and top two (2) screws as shown in Figure 147.

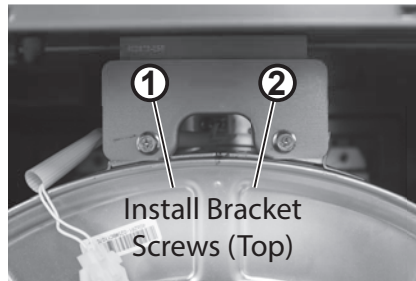

Figure 147 - Heat exchanger install bracket

▲ WARNING! Once top screws are removed from bracket the heat exchanger will come free. Properly support the weight of the heat exchanger when removing screws. Failure to properly support the weight of the heat exchanger could cause property damage or personal injury.

- 47** Remove the top two (2) screws from install bracket. Allow heat exchanger to lean slightly forward. Lift up to remove heat exchanger tab from hanger assembly and remove heat exchanger from water heater. See Figure 148 & Figure 149 for reference.

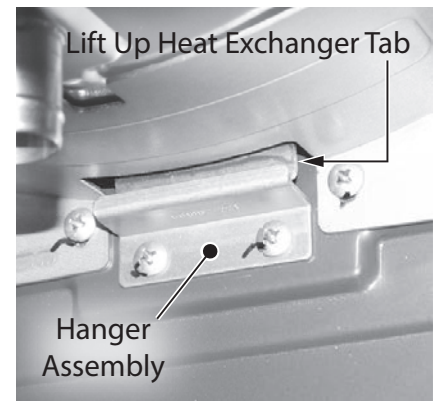

Figure 148 - Heat exchanger tab and hanger (bottom side of heat exchanger)



Figure 149 - Remove heat exchanger

Preparing New Heat Exchanger for Installation

- 48** Locate the two (2) bottom screws securing install bracket to old heat exchanger as shown in Figure 150. Remove screws and install bracket from old heat exchanger. Secure install bracket to the new heat exchanger with the two (2) bottom screws.

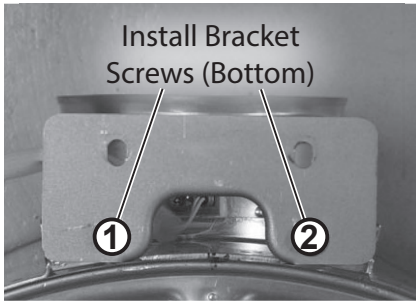

Figure 150 - Heat exchanger install bracket

49 Dispose of old heat exchanger properly.

50 Locate the exhaust gasket provided in the kit. Orient gasket so side with small flat surface is facing downward. The side facing upward will have a slight bevel. See Figure 151 as reference.

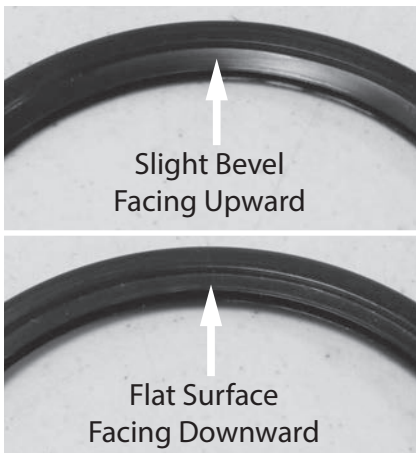

Figure 151 - Orient exhaust gasket

NOTICE: Handle with care and verify lubricant has been applied to gasket. Confirm gasket is not dirty or damaged.

51 Install exhaust gasket to groove in heat exchanger exhaust as shown in Figure 152.



Figure 152 - Install exhaust gasket

52 Locate the two (2) O-rings provided in the kit. Install O-rings to the inlet and outlet HEX tube connections as shown in Figure 153.

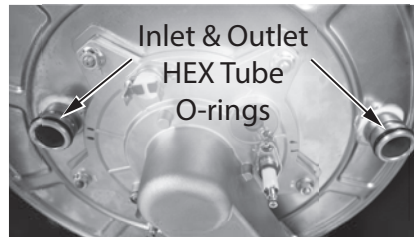

Figure 153 - Install new O-rings

NOTICE: Handle with care and verify lubricant has been applied to O-rings. Confirm O-rings are not dirty or damaged.

Installing New Heat Exchanger



Lifting Risk

⚠ WARNING! The heat exchanger is heavy. Follow these precautions to reduce the risk of property damage, injuries from lifting or impact injuries from dropping the water heater.

53 Locate the top two (2) install bracket screws previously removed in **Step 47**. Place both screws and a Phillips screwdriver on top of water heater cabinet for ease of access when installing heat exchanger.

54 Lift heat exchanger into water heater cabinet. Lean the top side of heat exchanger slightly toward you so the tab at the bottom inserts into the hanger assembly as shown in Figure 154. Once the tab is inserted, push heat exchanger upright so the screw holes in the install bracket align with bracket in cabinet as shown in Figure 155.

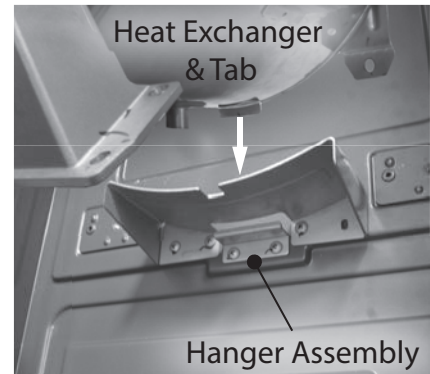

Figure 154 - Insert tab into hanger

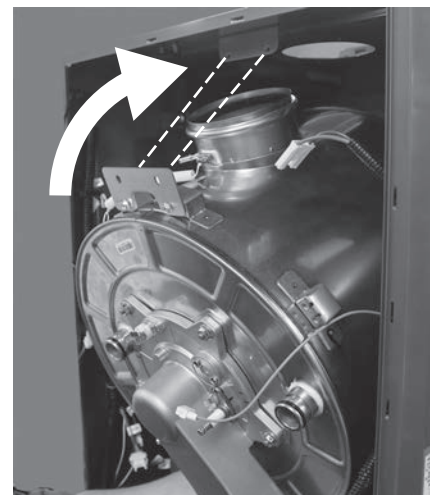

Figure 155 - Install heat exchanger to water heater

55 Hold heat exchanger in place and secure with the top two (2) screws placed on the water heater cabinet in **Step 53**.

56 Verify the four (4) screw holes in vertical brackets properly align with screw holes in water heater cabinet. To realign heat

SERVICE

exchanger screw holes, lift heat exchanger from underneath and shift left or right to center tab in hanger assembly.

57 Locate the four (4) screws previously removed in **Steps 40-43**. Use screws to secure the vertical brackets using the appropriate hex socket and extension (or use a 12" Phillips screwdriver).

IMPORTANT! The heat exchanger is now secured to the water heater and fully supported.

58 Locate exhaust port and the four (4) screws previously removed in **Step 44**. Install exhaust port to water heater cabinet and secure with screws. Confirm emissions port is facing the front of the water heater. Reconnect exhaust piping and confirm connection is tight.

Connecting Condensate Hose

59 Locate the black hose previously removed from the condensate trap and heat exchanger in **Step 21**. Connect hose to condensate trap. Connect the other end of hose to the back of heat exchanger. Secure connection at heat exchanger with spring clamp as shown in Figure 134. Confirm connections are tight and will not leak.

Installing HEX Inlet Tube

60 Locate the HEX inlet tube previously removed in **Step 25**. Follow **Steps 23-25** in reverse order to secure HEX inlet tube to outlet tee and heat exchanger. Confirm connections are tight and will not leak.

NOTICE: To secure HEX inlet tube to heat exchanger, align fastener previously removed in **Step 24** with slots in HEX inlet tube and push fastener inward until it is secure.

Installing Heater Blocks

61 Locate the two (2) heater blocks and two (2) brackets (size 20) previously removed in **Step 22**. Install heater blocks to HEX inlet tube and secure with brackets as shown in Figure 135.

Installing HEX Outlet Tube

62 Locate the HEX outlet tube previously disconnected in **Step 29**. Follow **Steps 26-29** in reverse order to secure HEX outlet tube to mixing tee and heat exchanger. Confirm connections are tight and will not leak.

NOTICE: To secure HEX outlet tube to heat exchanger, align fastener previously removed in **Step 27** with slots in HEX outlet tube and push fastener inward until it is secure.

Connecting Burner Door Hi-Limit & Exhaust Thermistor

63 Follow **Steps 34-35** in reverse order to connect burner door hi-limit and exhaust thermistor wiring. Confirm connections are tight and routed properly as shown in Figure 143.

Installing Pressure Switch Assembly

64 Connect tubing from pressure switch assembly to the port located on the heat exchanger exhaust as shown in Figure 30. Confirm tubing is fully secured to heat exchanger. Confirm tubing is connected to the positive terminal (black side) of the pressure switch assembly as shown in Figure 144.

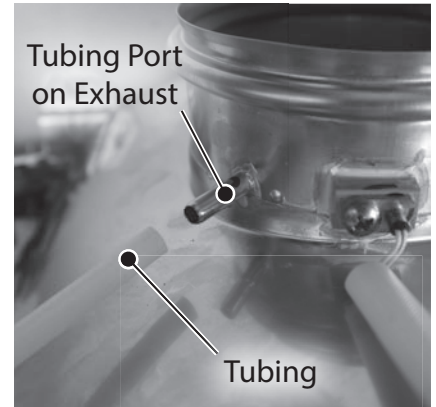

Figure 156 - Install tubing to heat exchanger

65 Connect pressure switch wires previously removed in **Step 39**. Red connection is on the right and black connection is on the left. Confirm connections are tight and routed properly as shown in Figure 144.

66 Install pressure switch assembly to heat exchanger. Secure with the two (2) screws previously removed in **Step 38**.

Installing Ignitor Assembly

67 Locate the ignitor assembly and two (2) screws previously removed in **Step 33**. Follow **Steps 31-33** in reverse order to secure ignitor assembly to water heater.

Connecting Flame Sensor & Ignitor Rod Caps

68 Connect the green ground wire to the ignitor rod assembly previously removed in **Step 30**. Locate the flame sensor and ignitor rod caps and install them. Caps will click into place when secured.

Installing Fan & Venturi Assembly

69 Locate the fan and venturi assembly previously removed in **Step 20**. Follow **Steps**

17-20 in reverse order to secure fan and venturi assembly to water heater. Confirm connections are tight and will not leak.

NOTICE: Confirm the burner tab engages the fan slot as shown in Figure 157.

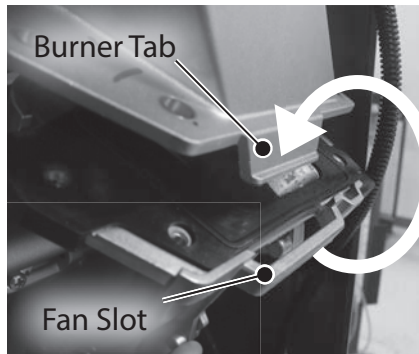

Figure 157 - Burner tab and fan slot

Checking for Water Leaks

70 Turn **ON** the cold water supply to the water heater at the cold inlet valve. The system will fully pressurize and any leaks at water connections will be apparent. Correct any leaks immediately and dry water heater cabinet with a rag.

Checking for Gas Leaks

71 Lift the control board panel up and reconnect the fan wiring harness previously disconnected in **Step 14**. Lower control board panel.

72 Turn **ON** the gas supply to the water heater at the manual gas shut off valve.

73 Restore power to the water heater.

74 Open all hot water fixtures in the house. This will initiate the call for heat at the water heater.

75 Use code approved methods to check for leaks around all gas connection points and the heat exchanger. To protect graphite gaskets from water damage, **DO NOT** perform a bubble test. If any leaks are detected, resecure components and recheck for leaks.

76 The water heater is ready for operation once there are no leaks detected.

Returning Water Heater to Operation

77 Lift the control board panel up and lock into place. Install and tighten the screw to the control board panel previously removed in **Step 15**.

78 Replace the cabinet cover and secure with the screws previously removed in **Step 12**.

INLET FILTER REPLACEMENT KIT INSTRUCTIONS

Kit 100371184 Contains:

- Inlet Filter
- O-ring (2.4 x 12)
- Kit Instructions

IMPORTANT: Use only factory authorized replacement parts. **DO NOT USE ELECTRIC SCREWDRIVERS OR DRILLS, HAND TIGHTEN ALL SCREWS TO PREVENT OVER TIGHTENING.** If you lack the necessary skills to properly perform the installation, you should not proceed, but get help from a qualified service technician.

Tools and Materials Required:

- Pliers
- Towel or Rag
- Bucket or Pan
- Safety Gloves

Preparing Water Heater for Service

1 Disconnect power to the water heater by unplugging it or by turning off the circuit at the breaker box, as appropriate. The power button on the water heater and remote **DOES NOT** disconnect power to the water heater. You must physically disconnect power to the water heater.

2 Shut **OFF** the gas supply to the water heater at the manual gas shut off valve.

3 Shut **OFF** the cold water supply to the water heater at the cold inlet valve.

4 Open all hot water fixtures in the house. When the residual water flow has ceased, close all hot water fixtures. This will depressurize the water heater.

SERVICE

5 Place a bucket or pan underneath the water heater to collect water during removal.

6 Remove the old inlet filter and dispose of it properly.

Installing New Inlet Filter

7 Locate the new inlet filter and O-ring provided in the kit. Install the O-ring to the inlet filter. See Figure 1.

NOTICE: Handle with care and verify lubricant has been applied to O-ring and O-ring is not dirty or damaged.

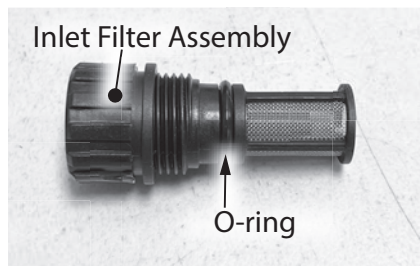

Figure 158 - O-ring location

8 Install the new inlet filter to water heater hand tight. Use caution and **DO NOT** damage the inlet filter.

Returning Water Heater to Operation

9 Turn **ON** the cold water supply to the water heater at the cold inlet valve. The system will fully pressurize and any leaks at water connections will be apparent. Correct any leaks immediately.

10 Turn **ON** the gas supply to the water heater at the manual gas shut off valve.

11 Restore power to the water heater. The water heater is now ready for operation.

WATER PUMP & TUBING REPLACEMENT KIT INSTRUCTIONS

Kit 100371191 Contains:

- Water Pump
- O-ring (15.5 x 2.5)
- O-ring (14 x 2.5)
- Double-Seal O-ring (16 x 7)
- Double-Seal O-ring (14 x 7)
- Kit Instructions

Kit 100371183 Contains:

- Pump Inlet Elbow
- (2x) O-ring (15.5 x 2.5)
- Double-Seal O-ring (16 x 7)
- Kit Instructions

Kit 100371203 Contains:

- Pump Outlet Tube
- O-ring (15.5 x 2.5)
- O-ring (14 x 2.5)
- Double-Seal O-ring (14 x 7)
- Kit Instructions

IMPORTANT: Use only factory authorized replacement parts. **DO NOT USE ELECTRIC SCREWDRIVERS OR DRILLS, HAND TIGHTEN ALL SCREWS TO PREVENT OVER TIGHTENING.** If you lack the necessary skills to properly perform the installation, you should not proceed, but get help from a qualified service technician.

Tools and Materials Required:

- 12" Phillips Screwdriver (magnitized)
- Towel or Rag
- Bucket or Pan
- Safety Gloves

Preparing Water Heater for Service

1 Disconnect power to the water heater by unplugging it or by turning off the circuit at the breaker box, as appropriate. The power button on the water heater and remote **DOES NOT** disconnect

power to the water heater. You must physically disconnect power to the water heater.

- 2 Shut **OFF** the gas supply to the water heater at the manual gas shut off valve.
- 3 Shut **OFF** the cold water supply to the water heater at the cold inlet valve.
- 4 Open all hot water fixtures in the house. When the residual water flow has ceased, close all hot water fixtures. This will depressurize the water heater.

Draining the Water Heater

- 5 Drain the X3®/Bypass Cartridge. Place a bucket or pan underneath cartridge to collect water during removal.
- 6 Locate the three (3) screws securing the X3®/Bypass cartridge as shown in Figure 1. Remove the (A) M4-12mm screw and the two (B) M4-25mm screws from cartridge. Place screws aside in a safe place for reinstallation.

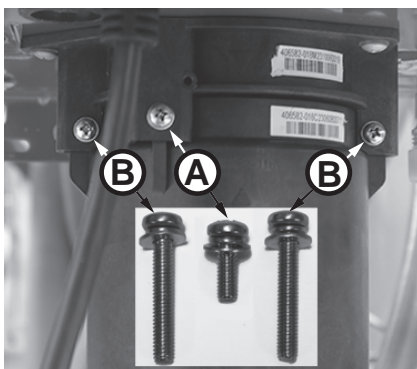

Figure 159 - Identify cartridge screws

- 7 Pull down to remove the cartridge from the water heater. Wait a few minutes to ensure all water has completely drained.

- 8 Locate and remove the inlet filter as shown in Figure 160 to drain any residual water left in the system.

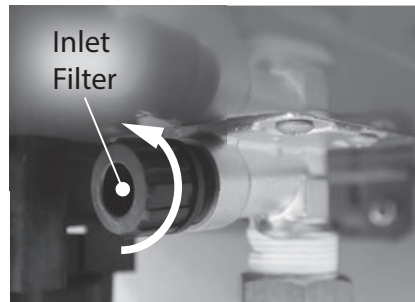

Figure 160 - Locate and remove inlet filter

- 9 Once the water heater has been adequately drained, reinstall inlet filter to water heater and tighten by hand. Confirm inlet filter is secured to water heater.
- 10 Reinstall the cartridge to the water heater. Insert the cartridge into manifold and secure with the two (2) long screws and one (1) short screw previously set aside in **Step 6**.

NOTICE: The X3® cartridge is keyed to only install in one direction. Align the ▲ on the cartridge with the ▼ on the manifold. When inserting the cartridge, push up until the screw holes align. Some resistance is normal. The bypass cartridge is not keyed and will install in either direction.

- 11 Insert and snug all three (3) screws by hand. Use a screwdriver to tighten the two (B) screws first and lastly tighten screw (A). **DO NOT** use a drill or impact driver to tighten the screws.

Accessing Water Heater Components

- 12 Locate the two (2) screws at the bottom of the cabinet cover. Use a Phillips screwdriver to remove the screws.

Place screws aside in a safe place for reinstallation.

- 13 Lift cover up and away from cabinet to gain access to the water heater's internal components.
- 14 Locate the water pump wiring harness on the control board panel as shown in Figure 161. Disconnect and route the wiring out of the way for ease of removing the water pump.

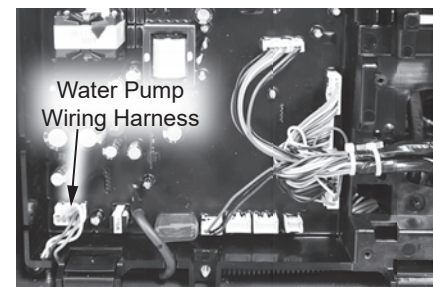

Figure 161 - Water pump wiring harness location

- 15 Locate the screw securing the control board panel. Use a Phillips screwdriver to remove the screw and place it aside in a safe place for reinstallation. See Figure 162.

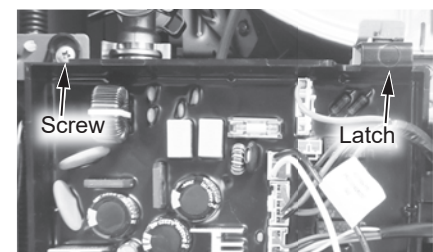

Figure 162 - Control board panel location

- 16 Press the latch at the top of the control board panel and pull the assembly forward from the top. It is hinged at the bottom and can be lowered. The control board assembly will hold itself in place.

SERVICE

Removing Bypass Valve

17 Locate the bypass valve at the bottom front side of the water heater as shown in Figure 163. Disconnect the wiring harness from the valve.

⚠ CAUTION! Water may still be present in the valve assembly. Place a rag under the valve connection points to prevent water from escaping into the water heater cabinet.

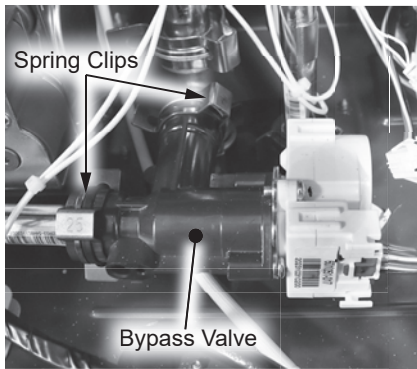

Figure 163 - Bypass valve location

18 Remove the two (2) spring clips (size 25) securing the bypass valve to the piping system. Remove the bypass valve from pipe connections. Place components aside in a safe place for reinstallation. See Figure 163.

Removing Flow Control Valve

19 Locate the flow control valve at the bottom right side of the water heater. See Figure 164.

⚠ CAUTION! Water may still be present in the valve assembly. Place a rag under the valve connection points to prevent water from escaping into the water heater cabinet.

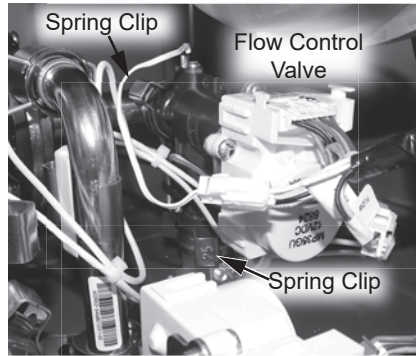

Figure 164 - Flow control valve location

20 Remove the two (2) spring clips (size 25) securing the flow control valve to the piping system. Place spring clips aside in a safe place for reinstallation. Remove the flow control valve from pipe connections and set aside in the water heater cabinet. See Figure 164.

Removing Heater Blocks

21 Locate the two heater blocks attached to the pump inlet elbow and the pump outlet tube as shown in Figure 165. Remove brackets (size 16) securing heater blocks to pipe connections. Place brackets aside in a safe place for reinstallation. Route heater blocks and wiring inside water heater cabinet for ease of access to water pump.

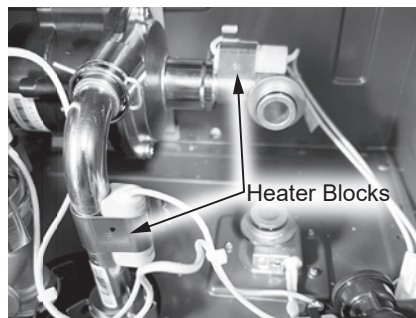

Figure 165 - Heater block locations

(For Kit 100371183 Only)

• Locate the pump inlet elbow. Remove the retaining clip securing elbow to water pump. Remove pump inlet elbow and dispose of properly. See Figure 166.

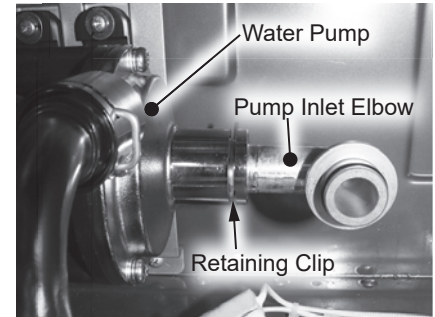

Figure 166 - Pump inlet elbow location

• Locate new pump inlet elbow and three (3) O-rings provided in the kit. The pump inlet elbow uses one (1) 15 x 2.5 O-ring on the inlet side, one (1) 16 x 7 double seal O-ring on the inlet side, and one (1) 15 x 2.5 O-ring on the outlet side. Install O-rings to elbow. Install elbow to water pump and secure with retaining clip. Proceed to **Step 33** if not replacing water pump. See Figure 167.

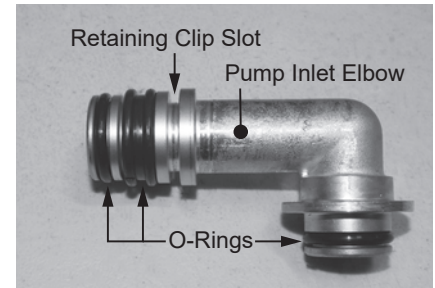

Figure 167 - Pump inlet elbow O-rings

(For Kit 100371203 Only)

- Locate the pump outlet tube. Remove the retaining clip securing tube to water pump. Locate and remove the spring clip (size 25) at the bottom of the pump outlet tube and disconnect tube from water connection and water pump. See Figure 168.

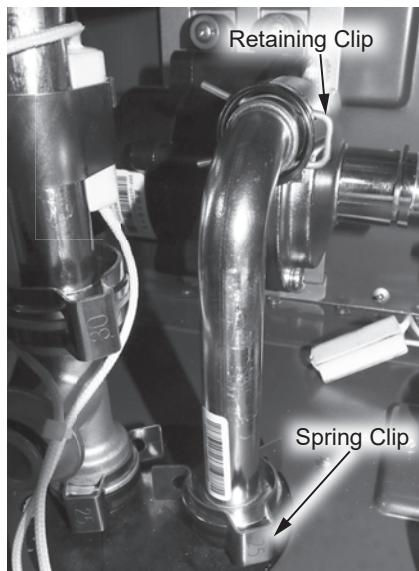

Figure 168 - Pump outlet tube location

- Locate new pump outlet tube and three (3) O-rings provided in the kit. The pump outlet tube uses one (1) 14 x 2.5 O-ring on the inlet side, one (1) 14 x 7 double seal O-ring on the inlet side, and one (1) 15 x 2.5 O-ring on the outlet side. Install O-rings to tube. Install tube to water pump and secure with retaining clip. Install tube to water connection and secure with spring clip (size 25). Proceed to **Step 33** if not replacing water pump. See Figure 169.

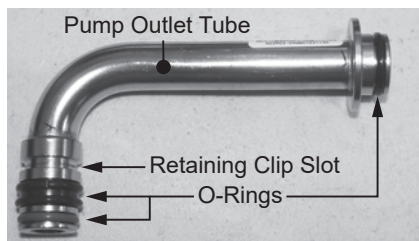

Figure 169 - Pump outlet tube O-rings

Removing Water Pump

- 22** Locate the four (4) screws securing the water pump assembly to the bracket at the back side of the water heater cabinet. Use a 12" Phillips screwdriver to loosen screws so they no longer engage bracket threads. Do not remove screws from gasket boots. See Figure 170.

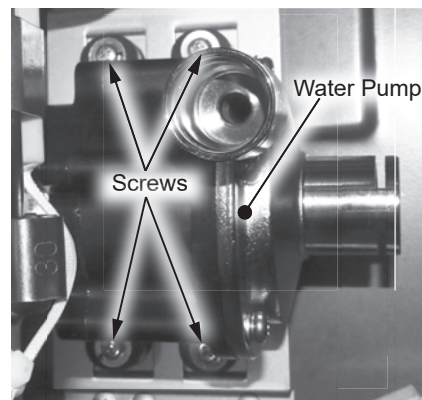

Figure 170 - Water pump screw locations

- 23** Locate and remove the spring clip (size 25) at the bottom of the pump outlet tube and disconnect tube from water connection.
- 24** With screws loosened and pump outlet tube disconnected, carefully remove water pump, tube, elbow, screws and wiring from water heater.

Preparing New Water Pump and Pipe Connections

- 25** Remove the four (4) gasket boots with screws from the old water pump by sliding them out of the brackets. Note orientation of gasket boots for proper installation to new water pump. See Figure 171.

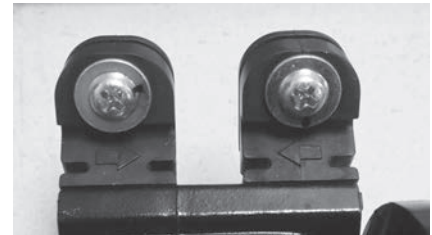

Figure 171 - Water pump gasket boot orientation

- 26** Remove the retaining clips securing the pump inlet elbow and pump outlet tube to water pump. Remove the pipe connections from the water pump.
- 27** Replace the O-rings on both water pipes with the new O-rings provided in the kit.

The pump inlet elbow uses one (1) 15 x 2.5 O-ring on the inlet side, one (1) 16 x 7 double seal O-ring on the inlet side, and one (1) 15 x 2.5 O-ring on the outlet side. See Figure 167.

The pump outlet tube uses one (1) 14 x 2.5 O-ring on the inlet side, one (1) 14 x 7 double seal O-ring on the inlet side, and one (1) 15 x 2.5 O-ring on the outlet side. See Figure 169.

NOTICE: Handle with care and verify lubricant has been applied to O-rings and O-rings are not dirty or damaged.

- 28** Install pump inlet elbow and pump outlet tube to the new water pump provided in the kit. Secure pipe connections with retaining clips previously removed in **Step 26**. Confirm water connections are tight and will not leak.
- 29** Dip the ends of the four (4) gasket boots in water and slide them into the brackets on the new water pump. The water will help gaskets slide smoothly into brackets. Directional arrows on gasket boots must be pointing inward toward one another. See Figure 13.

SERVICE

The new water pump is now ready for installation.

Installing New Water Pump

- 30** Place the water pump into the water heater cabinet, routing the wiring harness cable behind the condensate collector and under the control board panel as shown in Figure 3. Use caution not to dislodge screws in gasket boots.
- 31** Install the pump outlet tube to water connection and secure with the spring clip (size 25) previously removed in **Step 23**. This will keep the water pump rigid while securing to bracket with screws.
- 32** Align gasket boots and screws with screw holes in bracket. Use a 12" Phillips screwdriver to secure the bottom two screws first. Gently push upward on the water pump to help guide bottom screws through bracket holes. Once the bottom screws are tight, finish securing water pump by tightening the top two screws.
- 33** Locate the two (2) heater blocks and brackets (size 16) previously removed in **Step 21**. Secure heater blocks to pump inlet elbow and pump outlet tube as shown in Figure 165.
- 34** Install the flow control valve and the bypass valve to the water heater by following **Steps 17-20** in reverse order. Confirm all wiring connections are secure. Confirm all water connections are tight and will not leak.
- 35** Lift the control board panel up and reconnect the water pump wiring harness previously disconnected in **Step 14**. Slide the wiring through the slot in the circuit board panel as shown in Figure 161. Lower control board panel.

Checking for Water Leaks

- 36** Turn **ON** the cold water supply to the water heater at the cold inlet valve. The system will fully pressurize and any leaks at water connections will be apparent. Correct any leaks immediately and dry water heater cabinet with a rag.

Returning Water Heater to Operation

- 37** Lift the control board panel up and lock into place. Install and tighten the screw to the control board panel previously removed in **Step 15**.
- 38** Replace the cabinet cover and secure with the screws previously removed in **Step 12**.
- 39** Turn **ON** the gas supply to the water heater at the manual gas shut off valve.
- 40** Restore power to the water heater. The water heater is now ready for operation.

AIR INTAKE WATER TRAP REPLACEMENT KIT INSTRUCTIONS

Kit 100371209 Contains:

- Air Intake Water Trap
- Kit Instructions

IMPORTANT: Use only factory authorized replacement parts. **DO NOT USE ELECTRIC SCREWDRIVERS OR DRILLS, HAND TIGHTEN ALL SCREWS TO PREVENT OVERTIGHTENING.** If you lack the necessary skills to properly perform the installation, you should not proceed, but get help from a qualified service technician.

Tools and Materials Required:

- Phillips Screwdriver
- Safety Gloves

Preparing Water Heater for Service

- 1** Disconnect power to the water heater by unplugging it or by turning off the circuit at the breaker box, as appropriate. The power button on the water heater and remote **DOES NOT** disconnect power to the water heater. You must physically disconnect power to the water heater.
 - 2** Locate the two screws at the bottom of the cabinet cover. Use a Phillips screwdriver to remove the screws. Place screws aside in a safe place for reinstallation.
 - 3** Lift cover up and away from cabinet to gain access to the water heater's internal components.
- ## Removing the Air Intake Water Trap
- 4** Locate the air intake water trap on upper left side of the water heater. See Figure 172.

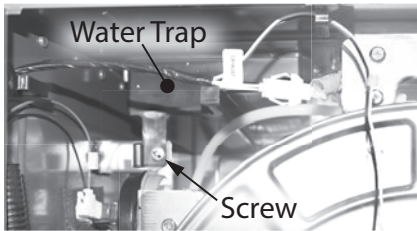

Figure 172 - Water trap location

5 Locate the screw securing the air intake water trap to the water heater. See Figure 1. Use a Phillips screwdriver to remove the screw. Place screw aside in a safe place for reinstallation.

6 Press the latch securing the air intake trap and carefully pull it from the water heater. See Figure 173.

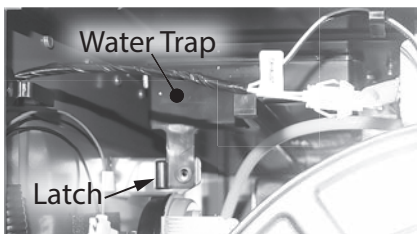

Figure 173 - Latch location

7 Dispose of the old air intake water trap properly.

Replacing the Air Intake Water Trap

8 Locate the new air intake water trap in the kit.

9 Install the air intake water trap in the water heater. Make sure the tab on the right side of the air intake water trap fully engages with the channel in the water heater. See Figure 174. Secure with the screw removed in **Step 5**.

NOTICE: The heat exchanger is not shown in Figure 174 for clarity.

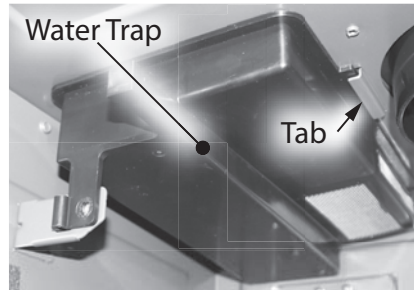

Figure 174 - Tab location

Returning Water Heater to Operation

10 Replace the cabinet cover and secure with the screws previously removed in **Step 3**.

11 Restore power to the water heater. The water heater is now ready for operation.

WATER PUMP & TUBING REPLACEMENT KIT INSTRUCTIONS

Kit 100371191 Contains:

- Water Pump
- O-ring (15.5 x 2.5)
- O-ring (14 x 2.5)
- Double-Seal O-ring (16 x 7)
- Double-Seal O-ring (14 x 7)
- Kit Instructions

Kit 100371183 Contains:

- Pump Inlet Elbow
- (2x) O-ring (15.5 x 2.5)
- Double-Seal O-ring (16 x 7)
- Kit Instructions

Kit 100371203 Contains:

- Pump Outlet Tube
- O-ring (15.5 x 2.5)
- O-ring (14 x 2.5)
- Double-Seal O-ring (14 x 7)
- Kit Instructions

IMPORTANT: Use only factory authorized replacement parts. **DO NOT USE ELECTRIC SCREWDRIVERS OR DRILLS, HAND TIGHTEN ALL SCREWS TO PREVENT OVERTIGHTENING.** If you lack the necessary skills to properly perform the installation, you should not proceed, but get help from a qualified service technician.

Tools and Materials Required:

- 12" Phillips Screwdriver (magnetized)
- Towel or Rag
- Bucket or Pan
- Safety Gloves

Preparing Water Heater for Service

1 Disconnect power to the water heater by unplugging it or by turning off the circuit at the breaker box, as appropriate. The power button on the water heater and remote **DOES NOT** disconnect power

SERVICE

to the water heater. You must physically disconnect power to the water heater.

- 2 Shut **OFF** the gas supply to the water heater at the manual gas shut off valve.
- 3 Shut **OFF** the cold water supply to the water heater at the cold inlet valve.
- 4 Open all hot water fixtures in the house. When the residual water flow has ceased, close all hot water fixtures. This will depressurize the water heater.

Draining the Water Heater

- 5 Drain the X3®/Bypass Cartridge. Place a bucket or pan underneath cartridge to collect water during removal.
- 6 Locate the three (3) screws securing the X3®/Bypass cartridge as shown in Figure 175. Remove the **(A)** M4-12mm screw and the two **(B)** M4-25mm screws from cartridge. Place screws aside in a safe place for reinstallation.

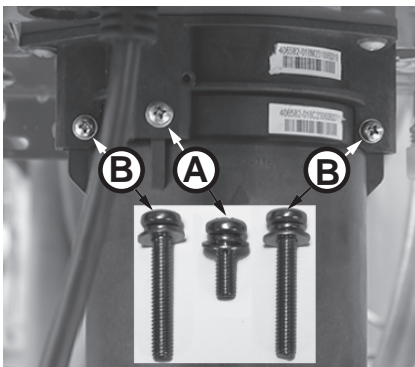

Figure 175 - Identify cartridge screws

- 7 Pull down to remove the cartridge from the water heater. Wait a few minutes to ensure all water has completely drained.

- 8 Locate and remove the inlet filter as shown in Figure 176 to drain any residual water left in the system.

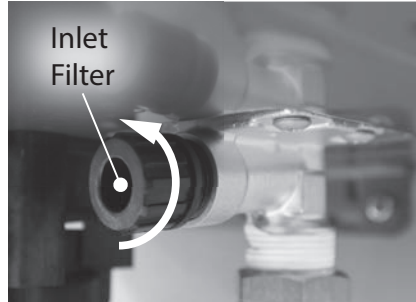

Figure 176 - Locate and remove inlet filter

- 9 Once the water heater has been adequately drained, reinstall inlet filter to water heater and tighten by hand. Confirm inlet filter is secured to water heater.
- 10 Reinstall the cartridge to the water heater. Insert the cartridge into manifold and secure with the two (2) long screws and one (1) short screw previously set aside in **Step 6**.

NOTICE: The X3® cartridge is keyed to only install in one direction. Align the ▲ on the cartridge with the ▼ on the manifold. When inserting the cartridge, push up until the screw holes align. Some resistance is normal. The bypass cartridge is not keyed and will install in either direction.

- 11 Insert and snug all three (3) screws by hand. Use a screwdriver to tighten the two **(B)** screws first and lastly tighten screw **(A)**. **DO NOT** use a drill or impact driver to tighten the screws.

Accessing Water Heater Components

- 12 Locate the two (2) screws at the bottom of the cabinet cover. Use a Phillips screwdriver to remove the screws.

Place screws aside in a safe place for reinstallation.

- 13 Lift cover up and away from cabinet to gain access to the water heater's internal components.
- 14 Locate the water pump wiring harness on the control board panel as shown in Figure 177. Disconnect and route the wiring out of the way for ease of removing the water pump.

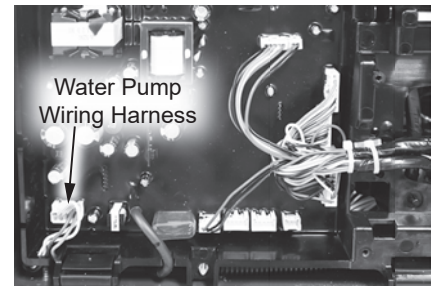

Figure 177 - Water pump wiring harness location

- 15 Locate the screw securing the control board panel. Use a Phillips screwdriver to remove the screw and place it aside in a safe place for reinstallation. See Figure 178.

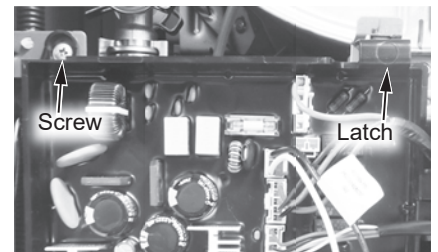

Figure 178 - Control board panel location

- 16 Press the latch at the top of the control board panel and pull the assembly forward from the top. It is hinged at the bottom and can be lowered. The control board assembly will hold itself in place.

Removing Bypass Valve

17 Locate the bypass valve at the bottom front side of the water heater as shown in Figure 179. Disconnect the wiring harness from the valve.

⚠ CAUTION! Water may still be present in the valve assembly. Place a rag under the valve connection points to prevent water from escaping into the water heater cabinet.

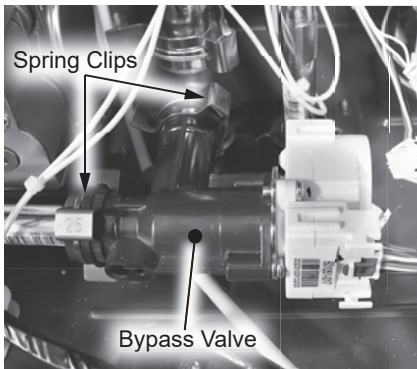

Figure 179 - Bypass valve location

18 Remove the two (2) spring clips (size 25) securing the bypass valve to the piping system. Remove the bypass valve from pipe connections. Place components aside in a safe place for reinstallation. See Figure 179.

Removing Flow Control Valve

19 Locate the flow control valve at the bottom right side of the water heater. See Figure 180.

⚠ CAUTION! Water may still be present in the valve assembly. Place a rag under the valve connection points to prevent water from escaping into the water heater cabinet.

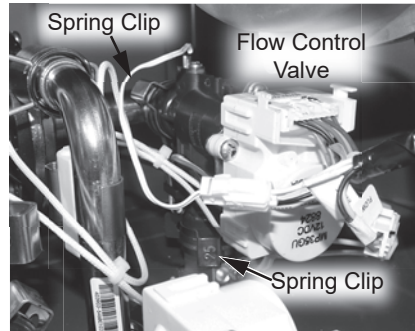

Figure 180 - Flow control valve location

20 Remove the two (2) spring clips (size 25) securing the flow control valve to the piping system. Place spring clips aside in a safe place for reinstallation. Remove the flow control valve from pipe connections and set aside in the water heater cabinet. See Figure 180.

Removing Heater Blocks

21 Locate the two heater blocks attached to the pump inlet elbow and the pump outlet tube as shown in Figure 181. Remove brackets (size 16) securing heater blocks to pipe connections. Place brackets aside in a safe place for reinstallation. Route heater blocks and wiring inside water heater cabinet for ease of access to water pump.

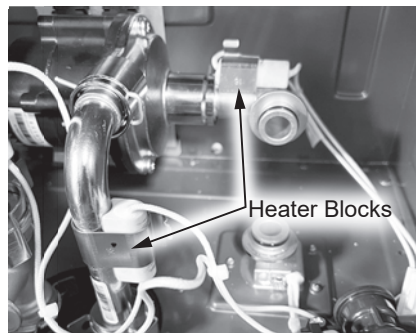

Figure 181 - Heater block locations

(For Kit 100371183 Only)

- Locate the pump inlet elbow. Remove the retaining clip securing elbow to water pump. Remove pump inlet elbow and dispose of properly. See Figure 182.

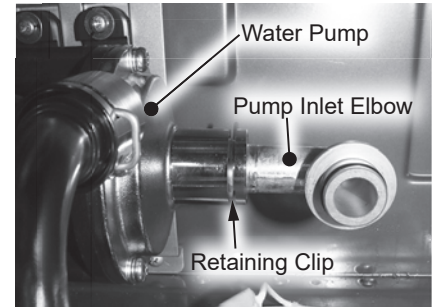

Figure 182 - Pump inlet elbow location

- Locate new pump inlet elbow and three (3) O-rings provided in the kit. The pump inlet elbow uses one (1) 15 x 2.5 O-ring on the inlet side, one (1) 16 x 7 double seal O-ring on the inlet side, and one (1) 15 x 2.5 O-ring on the outlet side. Install O-rings to elbow. Install elbow to water pump and secure with retaining clip. Proceed to **Step 33** if not replacing water pump. See Figure 183.

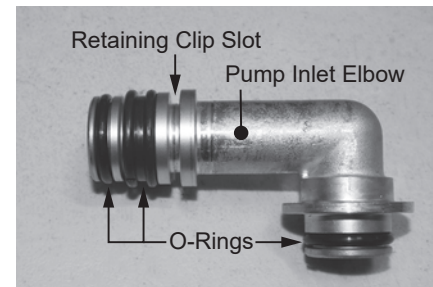

Figure 183 - Pump inlet elbow O-rings

(For Kit 100371203 Only)

- Locate the pump outlet tube. Remove the retaining clip securing tube to water pump. Locate and remove the spring clip (size 25) at the bottom of the pump outlet tube and disconnect tube from water connection and water pump. See Figure 184.

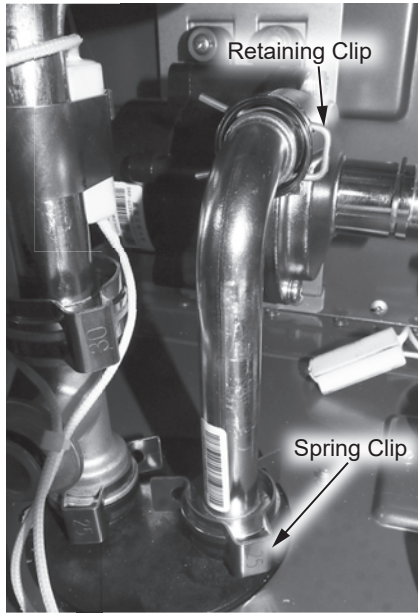

Figure 184 - Pump outlet tube location

- Locate new pump outlet tube and three (3) O-rings provided in the kit. The pump outlet tube uses one (1) 14 x 2.5 O-ring on the inlet side, one (1) 14 x 7 double seal O-ring on the inlet side, and one (1) 15 x 2.5 O-ring on the outlet side. Install O-rings to tube. Install tube to water pump and secure with retaining clip. Install tube to water connection and secure with spring clip (size 25). Proceed to **Step 33** if not replacing water pump. See Figure 185.

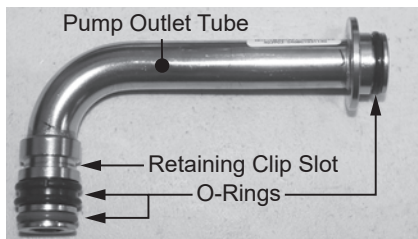

Figure 185 - Pump outlet tube O-rings

Removing Water Pump

- 22 Locate the four (4) screws securing the water pump assembly to the bracket at the back side of the water heater cabinet. Use a 12" Phillips screwdriver to loosen screws so they no longer

engage bracket threads. Do not remove screws from gasket boots. See Figure 186.

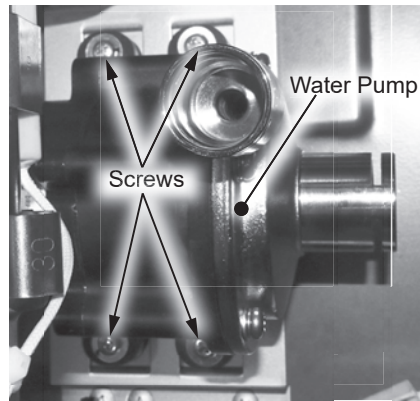

Figure 186 - Water pump screw locations

- 23 Locate and remove the spring clip (size 25) at the bottom of the pump outlet tube and disconnect tube from water connection.

- 24 With screws loosened and pump outlet tube disconnected, carefully remove water pump, tube, elbow, screws and wiring from water heater.

Preparing New Water Pump and Pipe Connections

- 25 Remove the four (4) gasket boots with screws from the old water pump by sliding them out of the brackets. Note orientation of gasket boots for proper installation to new water pump. See Figure 187.

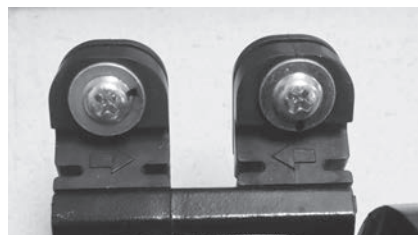

Figure 187 - Water pump gasket boot orientation

- 26 Remove the retaining clips securing the pump inlet elbow and pump outlet tube to water pump. Remove the pipe connections from the water pump.

- 27 Replace the O-rings on both water pipes with the new O-rings provided in the kit.

The pump inlet elbow uses one (1) 15 x 2.5 O-ring on the inlet side, one (1) 16 x 7 double seal O-ring on the inlet side, and one (1) 15 x 2.5 O-ring on the outlet side. See Figure 183.

The pump outlet tube uses one (1) 14 x 2.5 O-ring on the inlet side, one (1) 14 x 7 double seal O-ring on the inlet side, and one (1) 15 x 2.5 O-ring on the outlet side. See Figure 185.

NOTICE: Handle with care and verify lubricant has been applied to O-rings and O-rings are not dirty or damaged.

- 28 Install pump inlet elbow and pump outlet tube to the new water pump provided in the kit. Secure pipe connections with retaining clips previously removed in **Step 26**. Confirm water connections are tight and will not leak.

- 29 Dip the ends of the four (4) gasket boots in water and slide them into the brackets on the new water pump. The water will help gaskets slide smoothly into brackets. Directional arrows on gasket boots must be pointing inward toward one another. See Figure 187.

The new water pump is now ready for installation.

Installing New Water Pump

- 30 Place the water pump into the water heater cabinet, routing the wiring harness cable behind the condensate collector and under the control board panel as shown in Figure 177. Use caution not

to dislodge screws in gasket boots.

31 Install the pump outlet tube to water connection and secure with the spring clip (size 25) previously removed in **Step 23**. This will keep the water pump rigid while securing to bracket with screws.

32 Align gasket boots and screws with screw holes in bracket. Use a 12" Phillips screwdriver to secure the bottom two screws first. Gently push upward on the water pump to help guide bottom screws through bracket holes. Once the bottom screws are tight, finish securing water pump by tightening the top two screws.

33 Locate the two (2) heater blocks and brackets (size 16) previously removed in **Step 21**. Secure heater blocks to pump inlet elbow and pump outlet tube as shown in Figure 181.

34 Install the flow control valve and the bypass valve to the water heater by following **Steps 17-20** in reverse order. Confirm all wiring connections are secure. Confirm all water connections are tight and will not leak.

35 Lift the control board panel up and reconnect the water pump wiring harness previously disconnected in **Step 14**. Slide the wiring through the slot in the circuit board panel as shown in Figure 177. Lower control board panel.

Checking for Water Leaks

36 Turn **ON** the cold water supply to the water heater at the cold inlet valve. The system will fully pressurize and any leaks at water connections will be apparent. Correct any leaks immediately and dry water heater cabinet with a rag.

Returning Water Heater to Operation

37 Lift the control board panel up and lock into place. Install and tighten the screw to the control board panel previously removed in **Step 15**.

38 Replace the cabinet cover and secure with the screws previously removed in **Step 12**.

39 Turn **ON** the gas supply to the water heater at the manual gas shut off valve.

40 Restore power to the water heater. The water heater is now ready for operation.

HEX INLET & OUTLET TUBE REPLACEMENT KIT INSTRUCTIONS

Kit 100371200 Contains:

- HEX (Heat Exchanger) Inlet Tube
- (2x) O-ring (21.8 x 2.4)
- Kit Instructions

Kit 100371201 Contains:

- HEX (Heat Exchanger) Outlet Tube
- (2x) O-ring (21.8 x 2.4)
- Kit Instructions

IMPORTANT: Use only factory authorized replacement parts. **DO NOT USE ELECTRIC SCREWDRIVERS OR DRILLS, HAND TIGHTEN ALL SCREWS TO PREVENT OVER TIGHTENING.** If you lack the necessary skills to properly perform the installation, you should not proceed, but get help from a qualified service technician.

Tools and Materials Required:

- Phillips Screwdriver (magnetized)
- Flathead Screwdriver
- Mini Pick or Hook
- Towel or Rag
- Bucket
- Safety Gloves

Preparing Water Heater for Service

1 Disconnect power to the water heater by unplugging it or by turning off the circuit at the breaker box, as appropriate. The power button on the water heater and remote **DOES NOT** disconnect power to the water heater. You must physically disconnect power to the water heater.

2 Shut **OFF** the cold water supply to the water heater at the cold inlet valve.

3 Open all hot water fixtures in the house. When the residual water flow has ceased, close

SERVICE

all hot water fixtures. This will depressurize the water heater.

Draining the Water Heater

4 Drain the X3®/Bypass Cartridge. Place a bucket or pan underneath cartridge to collect water during removal.

5 Locate the three (3) screws securing the X3®/Bypass cartridge as shown in Figure 188. Remove the **(A)** M4-12mm screw and the two **(B)** M4-25mm screws from cartridge. Place screws aside in a safe place for reinstallation.

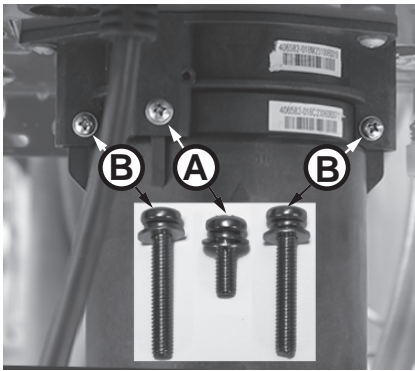

Figure 188 - Identify cartridge screws

6 Pull down to remove the cartridge from the water heater. Wait a few minutes to ensure all water has completely drained.

7 Locate and remove the inlet filter as shown in Figure 189 to drain any residual water left in the system. Place a bucket or pan underneath inlet filter to collect water during removal.

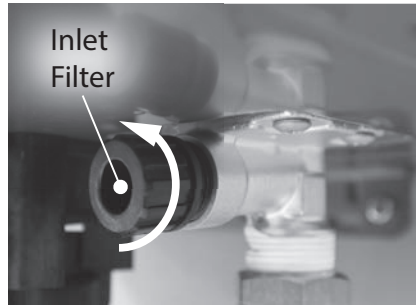

Figure 189 - Removing the inlet filter

8 Once the water heater has been adequately drained, reinstall inlet filter to water heater and tighten by hand. Confirm inlet filter is secured to water heater.

9 Reinstall the cartridge to the water heater. Locate the screws previously removed in **Step 5**. Insert and snug all three (3) screws by hand.

NOTICE: The X3® cartridge is keyed to only install in one direction. Align the ▲ on the cartridge with the ▼ on the manifold. When inserting the cartridge, push up until the screw holes align. Some resistance is normal. The bypass cartridge is not keyed and will install in either direction.

10 Use a screwdriver to tighten the two **(B)** screws first and lastly tighten screw **(A)**. **DO NOT** use a drill or impact driver to tighten the screws.

Accessing Water Heater Components

11 Locate the two (2) screws at the bottom of the cabinet cover. Use a Phillips screwdriver to remove the screws. Place screws aside in a safe place for reinstallation.

12 Lift cover up and away from cabinet to gain access to the water heater's internal components.

13 Locate the screw securing the control board panel as shown in Figure 190. Use a Phillips screwdriver to remove the screw and place it aside in a safe place for reinstallation.

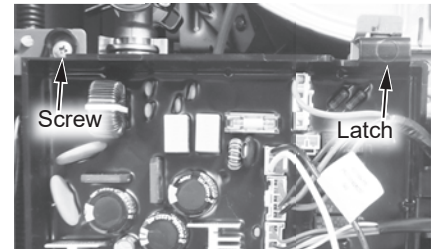

Figure 190 - Control board location

14 Press the latch at the top of the control board panel and pull the assembly forward from the top. It is hinged at the bottom and can be lowered. The control board assembly will hold itself in place.

(For Kit 100371200 Only)

15 Locate the two heater blocks attached to HEX inlet tube as shown in Figure 186. Remove brackets (size 20) securing heater blocks to tube. Place brackets aside in a safe place for reinstallation. Route heater blocks and wiring inside water heater cabinet for ease of HEX inlet tube removal.

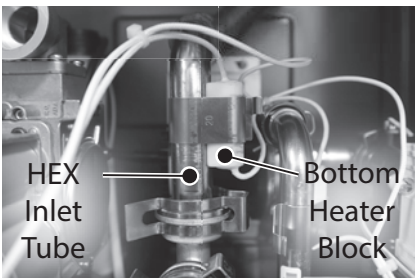
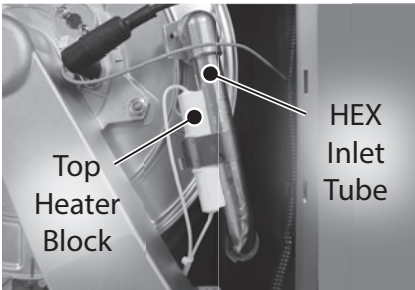

Figure 191 - Remove heater blocks from HEX inlet tube

- 16** Disconnect the spring clip (size 30) securing HEX inlet tube to outlet tee as shown in Figure 192.

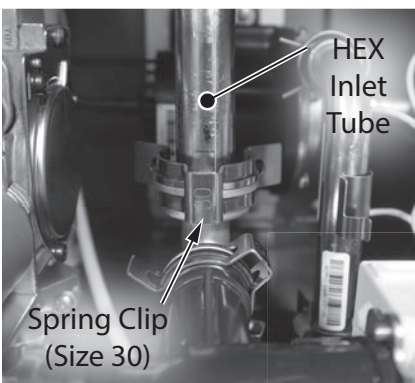

Figure 192 - Remove spring clip securing HEX inlet tube

- 17** Locate the fastener securing the HEX inlet tube to the heat exchanger. Use a flathead screwdriver to gently pry the fastener free. Remove fastener and place it aside in a safe place for reinstallation.

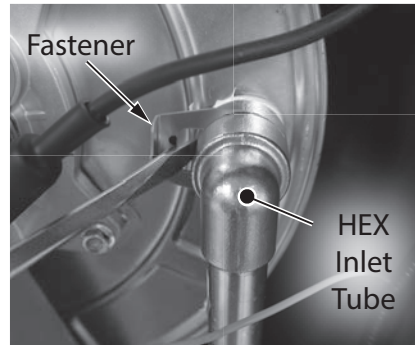

Figure 193 - Remove fastener securing HEX inlet tube

- 18** Disconnect HEX inlet tube from heat exchanger and outlet tee. To remove HEX inlet tube from water heater, lift upward and pull top of tube toward you as shown in Figure 194. Guide HEX inlet tube around the right side of heat exchanger and above fan assembly as shown in Figure 195. Dispose of HEX inlet tube properly.

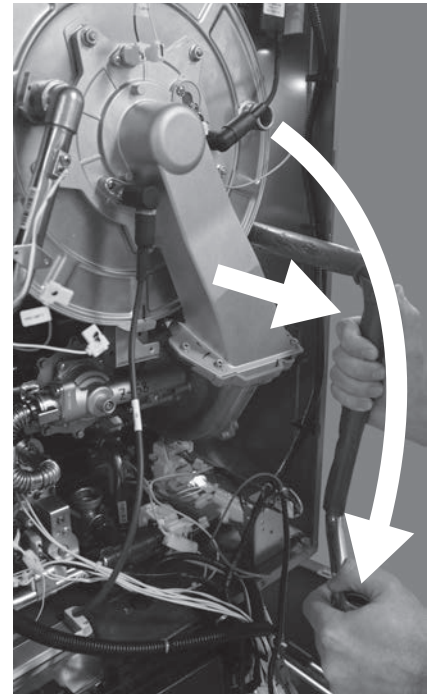

Figure 194 - Lift & pull HEX inlet tube toward you

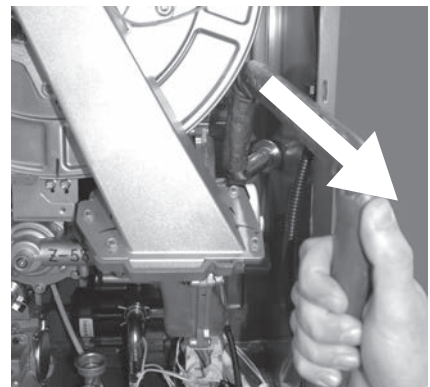

Figure 195 - Remove HEX inlet tube

- 19** Locate new HEX inlet tube and two (2) O-rings provided in the kit. Install the first O-ring to the male connection on the HEX inlet tube. Install the second O-ring to male connection on the heat exchanger.

NOTICE: Handle with care and verify lubricant has been applied to O-rings and O-rings are not dirty or damaged.

- 20** Install new HEX inlet tube to heat exchanger and outlet

SERVICE

tee. Secure to outlet tee with the spring clip (size 30) previously removed in **Step 16**.

NOTICE: To secure HEX inlet tube to heat exchanger, align fastener previously removed in **Step 17** with slots in HEX inlet tube and push fastener inward until it is secure.

- 21** Locate the two (2) heater blocks and two (2) brackets (size 20) previously removed in **Step 15**. Install heater blocks to tube and secure with brackets. Proceed to **Step 32**.

(For Kit 100371201 Only)

- 22** Locate the HEX outlet tube connected to the heat exchanger as shown in Figure 196 on the following page. Remove the spring clip (size 30) securing HEX outlet tube to mixing tee. Remove spring clip and place aside in a safe place for reinstallation.

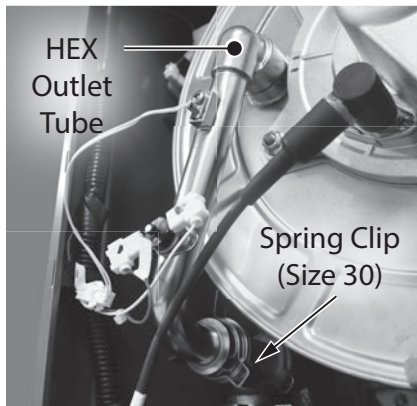

Figure 196 - Remove spring clip securing HEX outlet tube

- 23** Locate the hi-limit switch installed to the HEX outlet tube as shown in Figure 197. Disconnect the two (2) wire leads from the hi-limit switch (labeled "HI LIMIT 2"). Remove the two (2) screws securing hi-limit switch to HEX outlet tube. Remove hi-limit switch and place aside with the two (2) screws in a safe place for reinstallation.

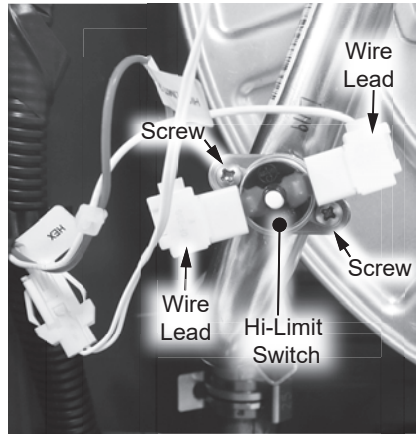

Figure 197 - Disconnect and remove hi-limit switch from HEX outlet tube

- 24** Locate the screw securing the outlet thermistor and clip to HEX outlet tube as shown in Figure 198. Remove screw and clip and place aside in a safe place for reinstallation. Disconnect thermistor and route wire to the side.

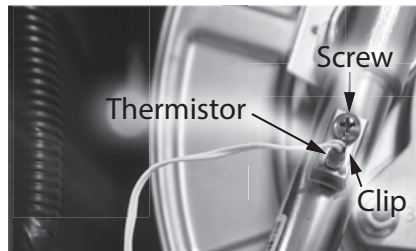

Figure 198 - Disconnect thermistor from HEX outlet tube

- 25** Use a mini pick or hook to remove the thermistor O-ring seated in the thermistor block. Place aside in a safe place for reinstallation.
- 26** Locate the fastener securing the HEX outlet tube to the heat exchanger. Use a flathead screwdriver to gently pry the fastener free. Remove fastener and place it aside in a safe place for reinstallation.

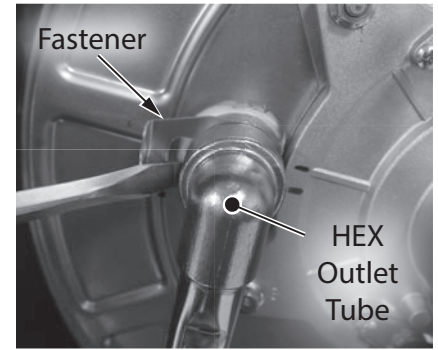

Figure 199 - Remove fastener securing HEX outlet tube

- 27** Disconnect HEX outlet tube from heat exchanger and mixing tee. Dispose of HEX outlet tube properly.

- 28** Locate new HEX outlet tube and two (2) O-rings provided in the kit. Install the first O-ring to the male connection on the mixing tee. Install the second O-ring to male connection on the heat exchanger.

NOTICE: Handle with care and verify lubricant has been applied to O-rings and O-rings are not dirty or damaged.

- 29** Install new HEX outlet tube to heat exchanger and mixing tee. Secure to mixing tee with the spring clip (size 30) previously removed in **Step 22**.

NOTICE: To secure HEX outlet tube to heat exchanger, align fastener previously removed in **Step 26** with slots in HEX outlet tube and push fastener inward until it is secure.

- 30** Locate the hi-limit switch and two (2) screws previously removed in **Step 23**. Install hi-limit switch to HEX outlet tube and secure with the two (2) screws. Connect the two (2) wire leads to hi-limit switch.

- 31** Locate the screw, clip, and thermistor O-ring previously removed in Steps **24 & 25**.

Install O-ring to thermistor and insert into thermistor block. Secure thermistor and O-ring with clip and screw.

Checking for Water Leaks

- 32** Turn **ON** the cold water supply to the water heater at the cold inlet valve. The system will fully pressurize and any leaks at water connections will be apparent. Correct any leaks immediately and dry water heater cabinet with a rag.
- 33** Lift the control board panel up and lock into place.
- 34** Install and tighten the screw to the control board panel previously removed in **Step 13**.
- 35** Replace the cabinet cover and secure with the screws previously removed in **Step 11**.
- 36** Restore power to the water heater. The water heater is now ready for operation.

WATER PIPING REPLACEMENT KIT INSTRUCTIONS

Kit 100371193 Contains:

- Mixing Tee
- (1x) O-ring (15.5 x 2.5)
- (2x) O-ring (21.8 x 2.4)
- Kit Instructions

Kit 100371202 Contains:

- Outlet Water Tube
- (2x) O-ring (21.8 x 2.4)
- Kit Instructions

IMPORTANT: Use only factory authorized replacement parts. **DO NOT USE ELECTRIC SCREWDRIVERS OR DRILLS, HAND TIGHTEN ALL SCREWS TO PREVENT OVER TIGHTENING.** If you lack the necessary skills to properly perform the installation, you should not proceed, but get help from a qualified service technician.

Tools and Materials Required:

- Phillips Screwdriver (magnetized)
- Towel or Rag
- Bucket
- Safety Gloves

Preparing Water Heater for Service

- 1** Disconnect power to the water heater by unplugging it or by turning off the circuit at the breaker box, as appropriate. The power button on the water heater and remote **DOES NOT** disconnect power to the water heater. You must physically disconnect power to the water heater.
- 2** Shut **OFF** the cold water supply to the water heater at the cold inlet valve.
- 3** Open all hot water fixtures in the house. When the residual water flow has ceased, close all hot water fixtures. This will depressurize the water heater.

Draining the Water Heater

- 4** Drain the X3®/Bypass Cartridge. Place a bucket or pan underneath cartridge to collect water during removal.
- 5** Locate the three (3) screws securing the X3®/Bypass cartridge as shown in Figure 200. Remove the **(A)** M4-12mm screw and the two **(B)** M4-25mm screws from cartridge. Place screws aside in a safe place for reinstallation.

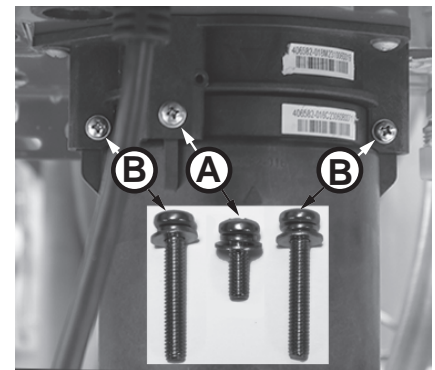

Figure 200 - Identify cartridge screws

- 6** Pull down to remove the cartridge from the water heater. Wait a few minutes to ensure all water has completely drained.
- 7** Locate and remove the inlet filter as shown in Figure 201 to drain any residual water left in the system. Place a bucket or pan underneath inlet filter to collect water during removal.

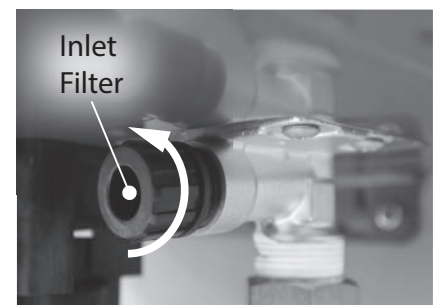

Figure 201 - Locate and remove inlet filter

SERVICE

8 Once the water heater has been adequately drained, reinstall inlet filter to water heater and tighten by hand. Confirm inlet filter is secured to water heater.

9 Reinstall the cartridge to the water heater. Locate the screws previously removed in

Step 5. Insert and snug all three (3) screws by hand.

NOTICE: The X3® cartridge is keyed to only install in one direction. Align the ▲ on the cartridge with the ▼ on the manifold. When inserting the cartridge, push up until the screw holes align. Some resistance is normal. The bypass cartridge is not keyed and will install in either direction.

10 Use a screwdriver to tighten the two (B) screws first and lastly tighten screw (A). **DO NOT** use a drill or impact driver to tighten the screws.

Accessing Water Heater Components

11 Locate the two (2) screws at the bottom of the cabinet cover. Use a Phillips screwdriver to remove the screws. Place screws aside in a safe place for reinstallation.

12 Lift cover up and away from cabinet to gain access to the water heater's internal components.

13 Locate the screw securing the control board panel as shown in Figure 202. Use a Phillips screwdriver to remove the screw and place it aside in a safe place for reinstallation.

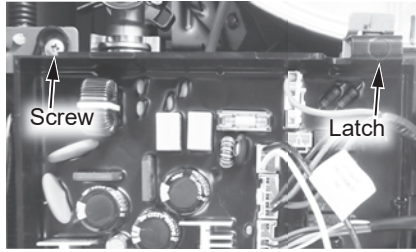

Figure 202 - Control board location

14 Press the latch at the top of the control board panel and pull the assembly forward from the top. It is hinged at the bottom and can be lowered. The control board assembly will hold itself in place.

Removing Mixing Tee

15 Locate the mixing tee and bypass water tube as shown in Figure 203. Remove the spring clip (size 25) securing bypass water tube to bypass valve and mixing tee. Place spring clip aside in a safe place for reinstallation.

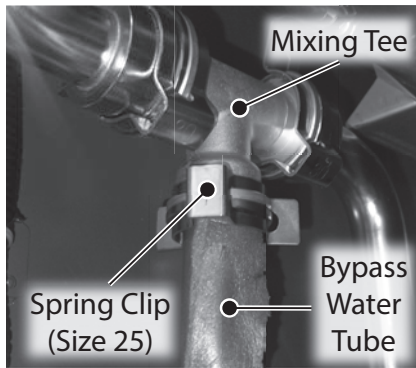

Figure 203 - Remove spring clip from bypass water tube

16 Remove the two (2) spring clips (size 30) securing mixing tee to HEX outlet tube and outlet water tube as shown in Figure 204. Place spring clips aside in a safe place for reinstallation.

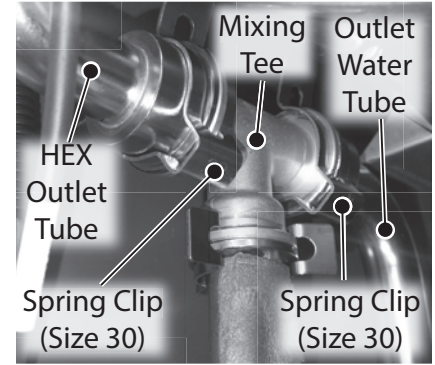

Figure 204 - Remove spring clips from HEX outlet tube and outlet water tube

17 Disconnect mixing tee from HEX outlet tube and outlet water tube. If not replacing mixing tee, place aside in a safe place for reinstallation and proceed to **Step 18.**

(For Kit 100371193 Only)

- Discard old mixing tee properly.
- Locate the new mixing tee and three (3) O-rings provided in the kit. Install the two (2) large O-rings (21.8 x 2.4) to mixing tee. Remove and replace the one (1) small O-ring (15.5 x 2.5) on the bypass water tube (mixing tee side). See Figure 203 for location of bypass water tube.

NOTICE: Handle with care and verify lubricant has been applied to O-rings and O-rings are not dirty or damaged.

- Proceed to **Step 25.**

Removing Outlet Water Tube

18 Locate the outlet water tube as shown in Figure 205. Remove the freeze protection thermostat from tube and set it aside in water heater cabinet for ease of outlet water tube removal.

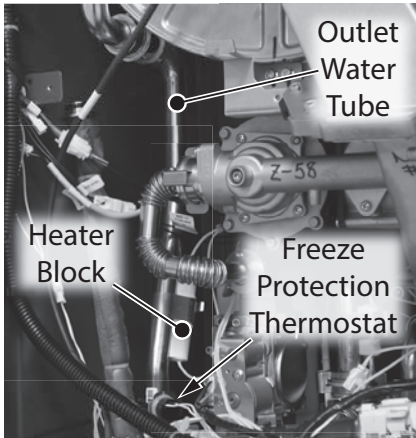

Figure 205 - Remove freeze protection thermostat and heater block from outlet water tube

19 Locate the heater block and bracket (size 20) attached to outlet water tube. Remove heater block and bracket as shown in Figure 6 above. Place bracket aside in a safe place for reinstallation. Route heater block and wiring inside water heater cabinet for ease of outlet water tube removal.

20 Locate and remove the spring clip (size 30) securing outlet water tube to hot outlet connection as shown in Figure 206. Place spring clip aside in a safe place for reinstallation.

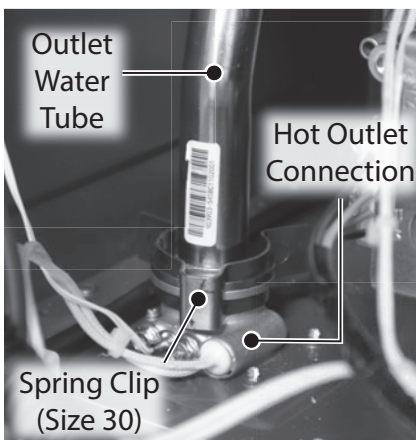

Figure 206 - Remove spring clip from outlet water tube

21 Disconnect outlet water tube from hot outlet connection.

(For Kit 100371202 Only)

- Discard old outlet water tube properly.
- Locate the new outlet water tube and two (2) O-rings (21.8 x 2.4) provided in the kit. Install one (1) O-ring to the new outlet water tube. Remove and replace the one (1) O-ring on the mixing tee (outlet water tube side) previously removed in **Step 17**.

NOTICE: Handle with care and verify lubricant has been applied to O-rings and O-rings are not dirty or damaged.

- Proceed to the next step on the following page.

Installing Outlet Water Tube

22 Connect outlet water tube to hot outlet connection. Secure outlet water tube with spring clip (size 30) previously removed in **Step 20**.

23 Install heater block and bracket (size 20) previously removed in **Step 19**.

24 Install the freeze protection thermostat previously removed in **Step 18**.

Installing Mixing Tee

25 Connect mixing tee to outlet water tube and HEX outlet tube. Secure mixing tee with the two (2) spring clips (size 30) previously removed in **Step 16**.

26 Connect bypass water tube to mixing tee and bypass valve. Secure bypass water tube with the spring clip (size 25) previously removed in **Step 15**.

Checking for Water Leaks

27 Turn **ON** the cold water supply to the water heater at the cold inlet valve. The system will fully pressurize and any leaks at water connections will be apparent. Correct any leaks immediately and dry water heater cabinet with a rag.

Returning Water Heater to Operation

28 Lift the control board panel up and lock into place.

29 Install and tighten the screw to the control board panel previously removed in **Step 13**.

30 Replace the cabinet cover and secure with the screws previously removed in **Step 11**.

31 Restore power to the water heater. The water heater is now ready for operation.

SERVICE

BYPASS VALVE & TUBING REPLACEMENT KIT INSTRUCTIONS

Kit 100371165 Contains:

- Bypass Valve
- (2x) O-ring (15.5 x 2.5)
- Kit Instructions

Kit 100371199 Contains:

- Bypass Water Tube
- (2x) O-ring (15.5 x 2.5)
- Kit Instructions

IMPORTANT: Use only factory authorized replacement parts. **DO NOT USE ELECTRIC SCREWDRIVERS OR DRILLS, HAND TIGHTEN ALL SCREWS TO PREVENT OVER TIGHTENING.** If you lack the necessary skills to properly perform the installation, you should not proceed, but get help from a qualified service technician.

Tools and Materials Required:

- Phillips Screwdriver
- Bucket or Pan
- Towel or Rag
- Safety Gloves

Preparing Water Heater for Service

- 1** Disconnect power to the water heater by unplugging it or by turning off the circuit at the breaker box, as appropriate. The power button on the water heater and remote **DOES NOT** disconnect power to the water heater. You must physically disconnect power to the water heater.
- 2** Shut **OFF** the gas supply to the water heater at the manual gas shut off valve.
- 3** Shut **OFF** the cold water supply to the water heater at the cold inlet valve.

- 4** Open all hot water fixtures in the house. When the residual water flow has ceased, close all hot water fixtures. This will depressurize the water heater.

Draining the Water Heater

- 5** Drain the X3®/Bypass Cartridge. Place a bucket or pan underneath cartridge to collect water during removal.
- 6** Locate the three (3) screws securing the X3®/Bypass cartridge as shown in Figure 207. Remove the **(A)** M4-12mm screw and the two **(B)** M4-25mm screws from cartridge. Place screws aside in a safe place for reinstallation.

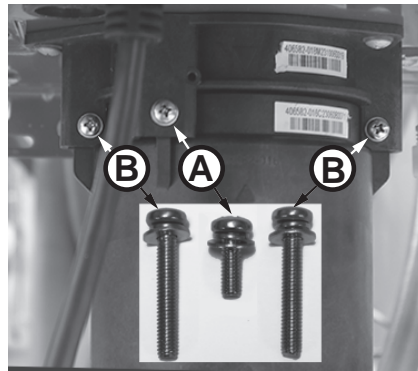

Figure 207 - Identify cartridge screws

- 7** Pull down to remove the cartridge from the water heater. Wait a few minutes to ensure all water has completely drained.
- 8** Locate and remove the inlet filter as shown in Figure 208 to drain any residual water left in the system. Place a bucket or pan underneath inlet filter to collect water during removal.

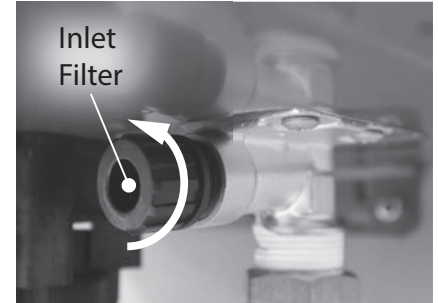

Figure 208 - Removing the inlet filter

- 9** Once the water heater has been adequately drained, reinstall inlet filter to water heater and tighten by hand. Confirm inlet filter is secured to water heater.
- 10** Reinstall the cartridge to the water heater. Locate the screws previously removed in **Step 6**. Insert and snug all three (3) screws by hand.

NOTICE: The X3® cartridge is keyed to only install in one direction. Align the ▲ on the cartridge with the ▼ on the manifold. When inserting the cartridge, push up until the screw holes align. Some resistance is normal. The bypass cartridge is not keyed and will install in either direction.

- 11** Use a screwdriver to tighten the two **(B)** screws first and lastly tighten screw **(A)**. **DO NOT** use a drill or impact driver to tighten the screws.

Accessing Water Heater Components

- 12** Locate the two (2) screws at the bottom of the cabinet cover. Use a Phillips screwdriver to remove the screws. Place screws aside in a safe place for reinstallation.
- 13** Lift cover up and away from cabinet to gain access to the water heater's internal components.

- 14** Locate the screw securing the control board panel as shown in Figure 209. Use a Phillips screwdriver to remove the screw and place it aside in a safe place for reinstallation.

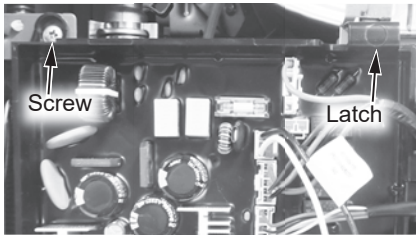

Figure 209 - Control board location

- 15** Press the latch at the top of the control board panel and pull the assembly forward from the top. It is hinged at the bottom and can be lowered. The control board assembly will hold itself in place.

Removing Bypass Water Tube

Proceed to **Step 21** if not replacing bypass water tube.

- 16** Locate the bypass water tube connected to the bypass valve. Locate and remove the two (2) spring clips (size 25) securing the tube to the bypass valve and the mixing tee as shown in Figure 210.

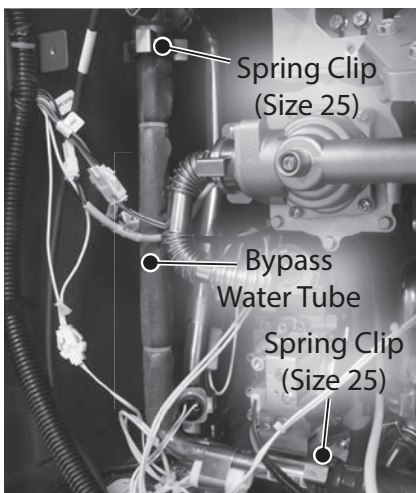

Figure 210 - Remove spring clips from bypass water tube

- 17** Locate the heater block attached to the tube as shown in Figure 211. Remove bracket (size 16) securing heater block to tube. Place bracket aside in a safe place for reinstallation. Route heater block and wiring inside water heater cabinet.

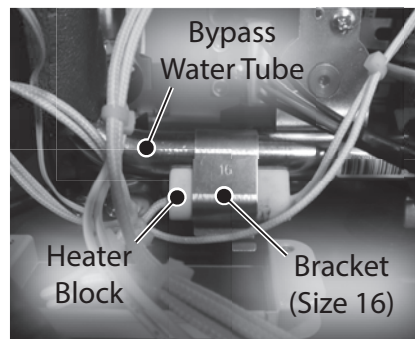

Figure 211 - Remove heater block and bracket from bypass water tube

- 18** Remove bypass water tube from bypass valve and mixing tee. Dispose of properly.

Installing New Bypass Water Tube

- 19** Locate the new bypass water tube and the two (2) O-rings provided in the kit. Install O-rings to the inlet and outlet of bypass water tube. Install bypass water tube to bypass valve and mixing tee. Secure tube with the two (2) spring clips (size 25) previously removed.

NOTICE: Handle with care and verify lubricant has been applied to O-rings and O-rings are not dirty or damaged.

- 20** Install heater block to bypass water tube and secure with bracket (size 16) previously removed. Proceed to **Step 30** if not replacing bypass valve.

Removing Bypass Valve

- 21** Locate the bypass valve at the bottom front side of the

water heater as shown in Figure 212. Disconnect the wiring harness from the valve.

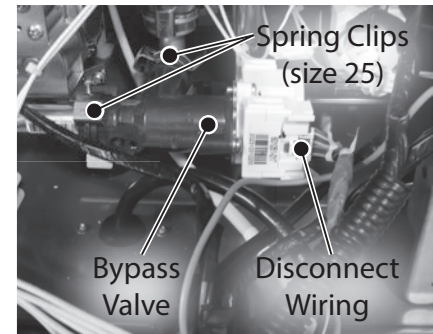

Figure 212 - Bypass valve

⚠ CAUTION! Water may still be present in the valve assembly. Place a rag under the valve connection points to prevent water from escaping into the water heater cabinet.

- 22** Remove the two (2) spring clips (size 25) securing the bypass valve to the piping system. Place the spring clips aside in a safe place for reinstallation.

- 23** Remove the bypass valve from the piping system and dispose of properly.

Installing New Bypass Valve

- 24** Locate the two (2) O-rings on the exposed water pipe connections as shown in Figure 213 and remove them. Dispose of O-rings properly.

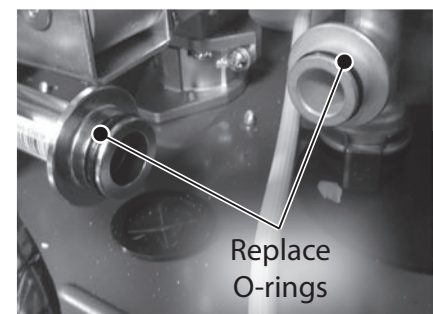

Figure 213 - Replace exposed O-rings

SERVICE

25 Locate the two (2) O-rings provided in the kit.

26 Install new O-rings to exposed water pipe connections.

NOTICE: Handle with care and verify lubricant has been applied to O-rings and O-rings are not dirty or damaged.

27 Locate the new bypass valve provided in the kit. Carefully install bypass valve to pipe connections.

28 Locate the two (2) spring clips previously removed in **Step 22**. Install spring clips to bypass valve, securing it to piping connections. Verify water connections are tight and will not leak.

29 Reconnect wiring harness to bypass valve. Confirm wiring connection is secure.

Checking for Water Leaks

30 Turn **ON** the cold water supply to the water heater at the cold inlet valve. The system will fully pressurize and any leaks at water connections will be apparent. Correct any leaks immediately and dry water heater cabinet with a rag.

Returning Water Heater to Operation

31 Lift the control board panel up and lock into place.

32 Install and tighten the screw to the control board panel previously removed in **Step**

14.

33 Replace the cabinet cover and secure with the screws previously removed in **Step**

12.

34 Turn **ON** the gas supply to the water heater at the manual gas shut off valve.

35 Restore power to the water heater. The water heater is now ready for operation.

FLOW CONTROL VALVE REPLACEMENT KIT INSTRUCTIONS

Kit 100371171 Contains:

- Flow Control Valve
- (2x) O-ring (15.5 x 2.5)
- Kit Instructions

IMPORTANT: Use only factory authorized replacement parts. **DO NOT USE ELECTRIC SCREWDRIVERS OR DRILLS, HAND TIGHTEN ALL SCREWS TO PREVENT OVER TIGHTENING.** If you lack the necessary skills to properly perform the installation, you should not proceed, but get help from a qualified service technician.

Tools and Materials Required:

- Phillips Screwdriver
- Towel or Rag
- Bucket or Pan
- Safety Gloves

Preparing Water Heater for Service

- 1 Disconnect power to the water heater by unplugging it or by turning off the circuit at the breaker box, as appropriate. The power button on the water heater and remote **DOES NOT** disconnect power to the water heater. You must physically disconnect power to the water heater.
- 2 Shut **OFF** the gas supply to the water heater at the manual gas shut off valve.
- 3 Shut **OFF** the cold water supply to the water heater at the cold inlet valve.
- 4 Open all hot water fixtures in the house. When the residual water flow has ceased, close all hot water fixtures. This will depressurize the water heater.

Draining the Water Heater

- 5 Drain the X3®/Bypass Cartridge. Place a bucket or pan underneath cartridge to collect water during removal.
- 6 Locate the three (3) screws securing the X3®/Bypass cartridge as shown in Figure 214. Remove the **(A)** M4-12mm screw and the two **(B)** M4-25mm screws from cartridge. Place screws aside in a safe place for reinstallation.

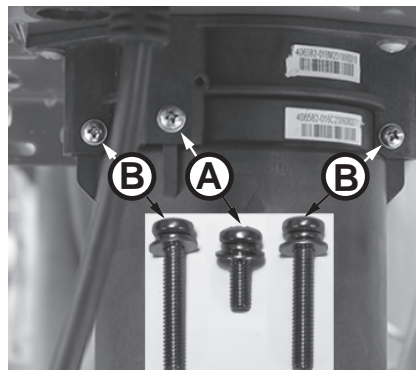

Figure 214 - Identify cartridge screws

- 7 Pull down to remove the cartridge from the water heater. Wait a few minutes to ensure all water has completely drained.
- 8 Locate and remove the inlet filter as shown in Figure 215 to drain any residual water left in the system. Place a bucket or pan underneath inlet filter to collect water during removal.

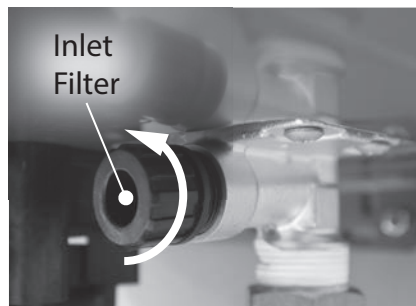

Figure 215 - Removing the inlet filter

- 9 Once the water heater has been adequately drained, reinstall inlet filter to water heater and tighten by hand. Confirm inlet filter is secured to water heater.
- 10 Reinstall the cartridge to the water heater. Locate the screws previously removed in **Step 6**. Insert and snug all three (3) screws by hand.

NOTICE: The X3® cartridge is keyed to only install in one direction. Align the **▲** on the cartridge with the **▼** on the manifold. When inserting the cartridge, push up until the screw holes align. Some resistance is normal. The bypass cartridge is not keyed and will install in either direction.

- 11 Use a screwdriver to tighten the two **(B)** screws first and lastly tighten screw **(A)**. **DO NOT** use a drill or impact driver to tighten the screws.

Accessing Water Heater Components

- 12 Locate the two (2) screws at the bottom of the cabinet cover. Use a Phillips screwdriver to remove the screws. Place screws aside in a safe place for reinstallation.
- 13 Lift cover up and away from cabinet to gain access to the water heater's internal components.
- 14 Locate the screw securing the control board panel. Use a Phillips screwdriver to remove the screw and place it aside in a safe place for reinstallation.

SERVICE

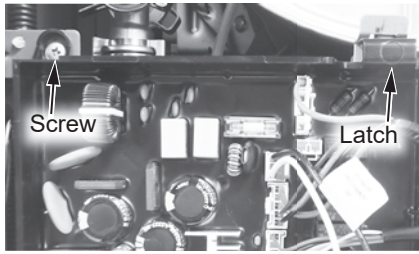

Figure 216 - Control board location

15 Press the latch at the top of the circuit board panel and pull the assembly forward from the top. It is hinged at the bottom and can be lowered. The circuit board assembly will hold itself in place. See Figure 216.

Removing Flow Control Valve

16 Locate the flow control valve at the bottom right side of the water heater as shown in Figure 217. Disconnect the three (3) wiring harnesses from the valve marked:

- "Water Valve 1"
- "Inlet"
- "Flow"

To disconnect the "Inlet" and "Flow" connections, use a pair of needle nose pliers to gently press down on the connector tab while pulling connections apart. See Figure 4.

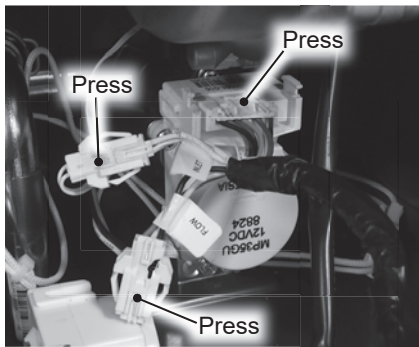

Figure 217 - Locating wiring harnesses

⚠ CAUTION! Water may still be present in the valve assembly. Place a rag under the valve connection points

to prevent water from escaping into the water heater cabinet.

17 Remove the two (2) spring clips (size 25) securing the flow control valve to the piping system. Place the spring clips aside in a safe place for reinstallation. See Figure 218.

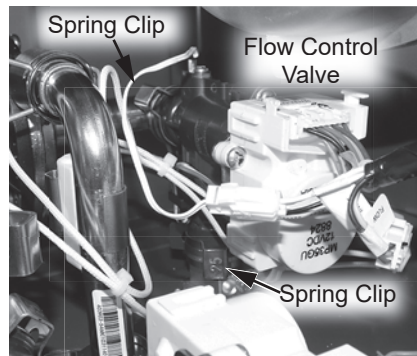

Figure 218 - Locating Flow Control Valve

18 Remove the flow control valve from the piping system and dispose of properly.

19 Locate the two (2) O-rings on the exposed water pipe connections as shown in

Figure 6 and remove them and install the new O-rings. Dispose of the old O-rings properly. See Figure 219.

NOTICE: Handle with care and verify lubricant has been applied to O-rings and O-rings are not dirty or damaged.

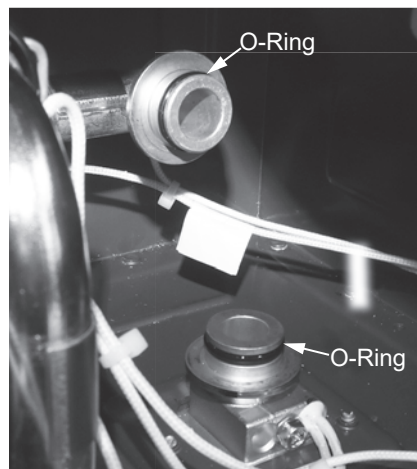

Figure 219 - Locating the O-rings

Installing New Flow Control Valve

20 Locate the new flow control valve provided in the kit. Carefully install flow control valve to pipe connections.

21 Locate the two (2) spring clips previously removed in **Step 17**. Install spring clips to flow control valve, securing it to piping connections. See Figure 5. Verify water connections are tight and will not leak.

22 Reconnect the three (3) wiring harnesses to the flow control valve previously disconnected in **Step 16**. Confirm wiring connections are secure. See Figure 217.

Checking for Water Leaks

23 Turn **ON** the cold water supply to the water heater at the cold inlet valve. The system will fully pressurize and any leaks at water connections will be apparent. Correct any leaks immediately and dry water heater cabinet with a rag.

Returning Water Heater to Operation

24 Lift the control board panel up and lock into place.

25 Install and tighten the screw to the circuit board panel previously removed in **Step**

14.

- 26 Replace the cabinet cover and secure with the screws previously removed in **Step 12**.
- 27 Turn **ON** the gas supply to the water heater at the manual gas shut off valve.
- 28 Restore power to the water heater. The water heater is now ready for operation.

INLET ASSEMBLY REPLACEMENT KIT INSTRUCTIONS

Kit 100371207 Contains:

- Inlet Assembly
- O-ring (15.5 x 2.5)
- Kit Instructions

IMPORTANT: Use only factory authorized replacement parts. **DO NOT USE ELECTRIC SCREWDRIVERS OR DRILLS, HAND TIGHTEN ALL SCREWS TO PREVENT OVER TIGHTENING.** If you lack the necessary skills to properly perform the installation, you should not proceed, but get help from a qualified service technician.

Tools and Materials Required:

- Phillips Screwdriver
- Thread Sealant/Pipe Dope
- Towel or Rag
- Bucket or Pan
- Safety Gloves

Preparing Water Heater for Service

- 1 Disconnect power to the water heater by unplugging it or by turning off the circuit at the breaker box, as appropriate. The power button on the water heater and remote **DOES NOT** disconnect power to the water heater. You must physically disconnect power to the water heater.
- 2 Shut **OFF** the gas supply to the water heater at the manual gas shut off valve.
- 3 Shut **OFF** the cold water supply to the water heater at the cold inlet valve.
- 4 Open all hot water fixtures in the house. When the residual water flow has ceased, close all hot water fixtures. This will depressurize the water heater.

Draining the Water Heater

- 5 Drain the X3®/Bypass Cartridge. Place a bucket or pan underneath cartridge to collect water during removal.
- 6 Locate the three (3) screws securing the X3®/Bypass cartridge as shown in Figure 220. Remove the **(A)** M4-12mm screw and the two **(B)** M4-25mm screws from cartridge. Place screws aside in a safe place for reinstallation.

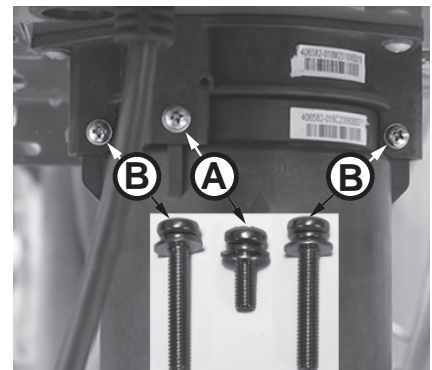

Figure 220 - Identify cartridge screws

- 7 Pull down to remove the cartridge from the water heater. Wait a few minutes to ensure all water has completely drained.
- 8 Locate and remove the inlet filter as shown in Figure 221 to drain any residual water left in the system.

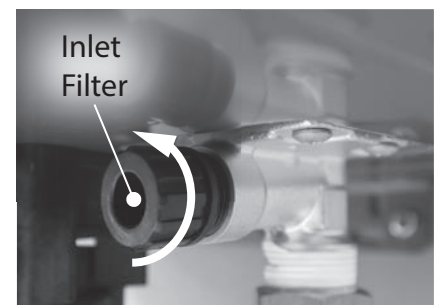

Figure 221 - Locate and remove inlet filter

- 9 Once the water heater has been adequately drained,

SERVICE

reinstall inlet filter to water heater and tighten by hand. Confirm inlet filter is secured to water heater.

- 10 Reinstall the cartridge to the water heater. Insert the cartridge into manifold and secure with the two (2) long screws and one (1) short screw previously set aside in **Step 6**.

NOTICE: The X3® cartridge is keyed to only install in one direction. Align the ▲ on the cartridge with the ▼ on the manifold. When inserting the cartridge, push up until the screw holes align. Some resistance is normal. The bypass cartridge is not keyed and will install in either direction.

- 11 Insert and snug all three (3) screws by hand. Use a screwdriver to tighten the two (B) screws first and lastly tighten screw (A). **DO NOT** use a drill or impact driver to tighten the screws.

- 12 Disconnect the cold water line to the cold inlet assembly.

Accessing Flow Control Valve

- 13 Locate the two (2) screws at the bottom of the cabinet cover. Use a Phillips screwdriver to remove the screws. Place screws aside in a safe place for reinstallation.

- 14 Lift cover up and away from cabinet to gain access to the water heater's internal components.

- 15 Locate the screw securing the control board panel. Use a Phillips screwdriver to remove the screw and place it aside in a safe place for reinstallation. See Figure 222.

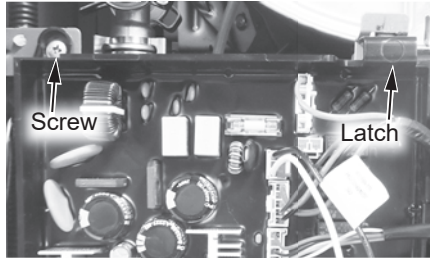

Figure 222 - Control Board screw location

- 16 Press the latch at the top of the circuit board panel and pull the assembly forward from the top. It is hinged at the bottom and can be lowered. The circuit board assembly will hold itself in place.

Removing the Flow Control Valve

- 17 Locate the flow control valve at the bottom right side of the water heater as shown in Figure 223.

▲ CAUTION! Water may still be present in the valve assembly. Place a rag under the valve connection points to prevent water from escaping into the water heater cabinet.

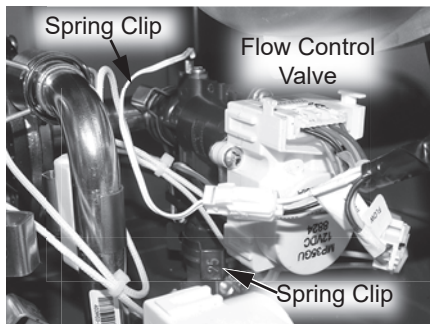

Figure 223 - Flow control valve location

- 18 Remove the two (2) spring clips (size 25) securing the flow control valve to the inlet assembly. Place the spring clips aside in a safe place for reinstallation.

- 19 Disconnect the flow control valve from the piping system and set it aside in the water heater cabinet.

Removing the Inlet Assembly

- 20 Locate the inlet assembly at the bottom right side of the water heater as shown in Figure 224.

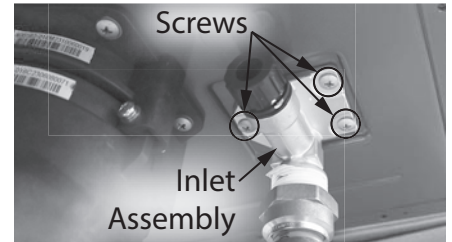

Figure 224 - Inlet assembly location

- 21 Locate the screw securing the heater block in the base of the inlet assembly. See Figure 225. Use a Phillips screwdriver to remove the screw. Place the screw aside in a safe place for reinstallation.

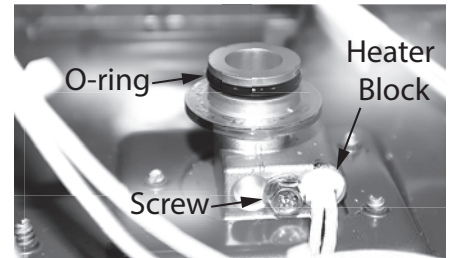

Figure 225 - Heater block location

- 22 Remove the heater block from the base and set aside for reinstallation.
- 23 Locate the three (3) screws securing the inlet assembly to the base of the water heater. Use a Phillips screwdriver to remove the screws. Place screws aside in a safe place for reinstallation. See Figure 224.
- 24 Remove the old inlet assembly from the piping system and dispose of properly.

Installing Inlet Assembly

25 Locate the new inlet assembly and O-ring provided in the kit.

26 Place the new O-ring on the new inlet assembly. See Figure 225.

NOTICE: Handle with care and verify lubricant has been applied to O-rings and O-rings are not dirty or damaged.

27 Place the new inlet assembly in the water heater and secure with the screws removed in **Step 23**.

28 Reinstall the heater block to the base of the inlet assembly and secure with the screw removed in **Step 21**.

Installing Flow Control Valve

29 Locate the flow control valve set aside earlier in **Step 19**. Carefully install flow control valve to pipe connections.

30 Locate the two (2) spring clips previously removed in **Step 18**. Install spring clips to flow control valve, securing it to piping connections. Verify water connections are tight and will not leak.

31 Reconnect the cold water line disconnected in **Step 12**. Use thread sealant tape or pipe dope when making the connection.

32 Turn **ON** the cold water supply to the water heater at the cold inlet valve. The system will fully pressurize and any leaks at water connections will be apparent. Correct any leaks immediately and dry water heater cabinet with a rag.

Returning Water Heater to Operation

33 Lift the circuit board panel up and lock into place.

34 Install and tighten the screw to the circuit board panel previously removed in **Step 15**.

35 Replace the cabinet cover and secure with the screws previously removed in **Step 13**.

36 Turn **ON** the gas supply to the water heater at the manual gas shut off valve.

37 Restore power to the water heater. The water heater is now ready for operation.

SERVICE

OUTLET ASSEMBLY REPLACEMENT KIT INSTRUCTIONS

Kit 100371208 Contains:

- Outlet Assembly
- O-ring (21.8 x 2.4)
- O-ring (3.8 x 1.9)
- Kit Instructions

IMPORTANT: Use only factory authorized replacement parts. **DO NOT USE ELECTRIC SCREWDRIVERS OR DRILLS, HAND TIGHTEN ALL SCREWS TO PREVENT OVER TIGHTENING.** If you lack the necessary skills to properly perform the installation, you should not proceed, but get help from a qualified service technician.

Tools and Materials Required:

- Phillips Screwdriver
- Thread Sealant/Pipe Dope
- Towel or Rag
- Bucket or Pan
- Safety Gloves

Preparing Water Heater for Service

- 1** Disconnect power to the water heater by unplugging it or by turning off the circuit at the breaker box, as appropriate. The power button on the water heater and remote **DOES NOT** disconnect power to the water heater. You must physically disconnect power to the water heater.
- 2** Shut **OFF** the gas supply to the water heater at the manual gas shut off valve.
- 3** Shut **OFF** the cold water supply to the water heater at the cold inlet valve.
- 4** Open all hot water fixtures in the house. When the residual water flow has ceased, close all hot water fixtures. This will depressurize the water heater.

Draining the Water Heater

- 5** Drain the X3®/Bypass Cartridge. Place a bucket or pan underneath cartridge to collect water during removal.
- 6** Locate the three (3) screws securing the X3®/Bypass cartridge as shown in Figure 226. Remove the **(A)** M4-12mm screw and the two **(B)** M4-25mm screws from cartridge. Place screws aside in a safe place for reinstallation.

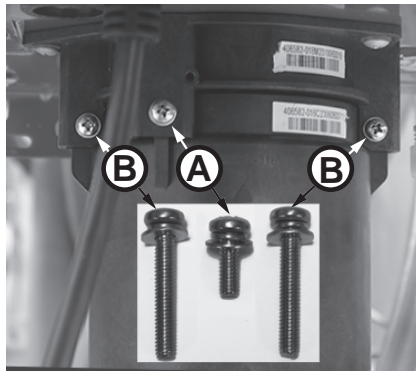

Figure 226 - Identify cartridge screws

- 7** Pull down to remove the cartridge from the water heater. Wait a few minutes to ensure all water has completely drained.
- 8** Locate and remove the inlet filter as shown in Figure 227 to drain any residual water left in the system.

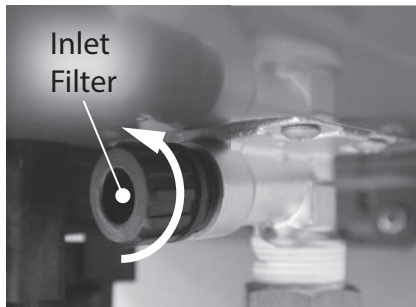

Figure 227 - Locate and remove inlet filter

- 9** Once the water heater has been adequately drained, reinstall inlet filter to water heater and tighten by hand. Confirm inlet filter is secured to water heater.
- 10** Reinstall the cartridge to the water heater. Insert the cartridge into manifold and secure with the two (2) long screws and one (1) short screw previously set aside in **Step 6**.

NOTICE: The X3® cartridge is keyed to only install in one direction. Align the ▲ on the cartridge with the ▼ on the manifold. When inserting the cartridge, push up until the screw holes align. Some resistance is normal. The bypass cartridge is not keyed and will install in either direction.

- 11** Insert and snug all three (3) screws by hand. Use a screwdriver to tighten the two **(B)** screws first and lastly tighten screw **(A)**. **DO NOT** use a drill or impact driver to tighten the screws.
 - 12** Disconnect the hot water line to the hot outlet assembly.
- ### Accessing Outlet Assembly
- 13** Locate the two (2) screws at the bottom of the cabinet cover. Use a Phillips screwdriver to remove the screws. Place screws aside in a safe place for reinstallation.

14 Lift cover up and away from cabinet to gain access to the water heater's internal components.

15 Locate the screw securing the control board panel. Use a Phillips screwdriver to remove the screw and place it aside in a safe place for reinstallation. See Figure 228.

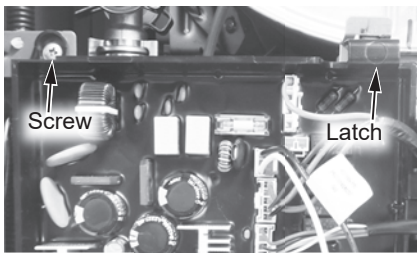

Figure 228 - Control Board screw location

16 Press the latch at the top of the circuit board panel and pull the assembly forward from the top. It is hinged at the bottom and can be lowered. The circuit board assembly will hold itself in place.

Removing the Outlet Assembly

17 Locate the spring clip (size 30) at the base of the outlet tube. See Figure 229. Remove and set this clip aside in a safe place for reinstallation.

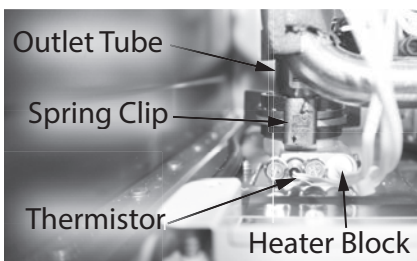

Figure 229 - Outlet tube location

⚠ CAUTION! Water may still be present in the valve assembly. Place a rag under the valve connection points to prevent water from escaping into the water heater cabinet.

18 Locate the three (3) screws securing the air inlet plate to the water heater cabinet. Use a Phillips screwdriver to remove the screws. Place screws aside in a safe place for reinstallation. See Figure 230. Note the orientation of the plate when removed and returning to that orientation when reinstalling it.

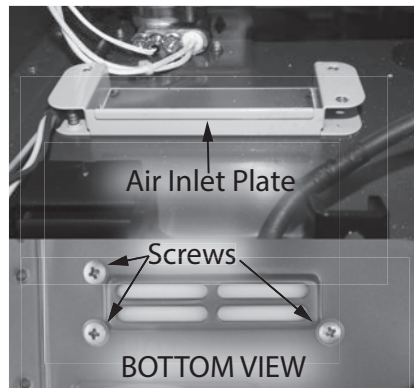

Figure 230 - Air inlet plate location

19 Locate the two (2) screws securing the thermistor and heating block to the outlet assembly. Use a Phillips screwdriver to remove the screws. Place screws aside in a safe place for reinstallation. See Figure 229.

20 Pull the heater block and thermistor from the outlet base and set aside for reinstallation.

21 Locate the three (3) screws securing the outlet assembly to the base of the water heater. Use a Phillips screwdriver to remove the screws. Place screws aside in a safe place for reinstallation. See Figure 231.

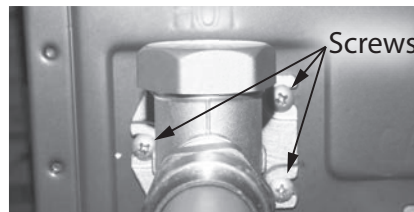

Figure 231 - Outlet assembly screw location

22 Pull down to remove the old outlet assembly from the piping system and dispose of properly.

Installing Outlet assembly

23 Locate the new outlet assembly and (21.8 x 2.4) O-ring provided in the kit.

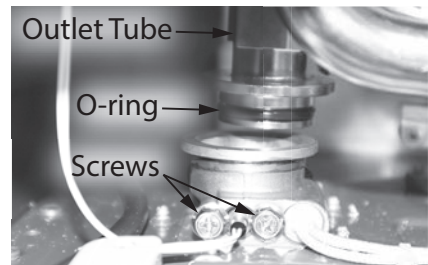

Figure 232 - O-ring location

24 Install the new (21.8 x 2.4) O-ring as shown in Figure 232.

NOTICE: Handle with care and verify lubricant has been applied to O-rings and O-rings are not dirty or damaged.

25 Place the new outlet assembly in the water heater and secure with the screws removed in **Step 21**.

26 Locate the (3.8 x 1.9) O-ring provided in the kit. Place the O-ring over the thermistor and install it in the outlet assembly base. See Figure 233.

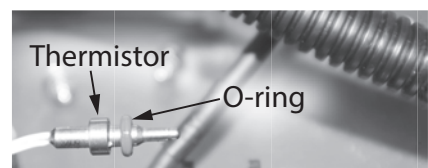

Figure 233 - Thermistor O-ring location

27 Reinstall the heater block to the base of the outlet assembly and secure with the screws removed in **Step 19**.

SERVICE

28 Locate the size (30) spring clip set aside earlier in **Step 17**. Reinstall the spring clip to secure the outlet pipe to the outlet assembly. Verify water connections are tight and will not leak.

29 Reinstall the air inlet plate and secure with the screws removed in **Step 18**.

30 Reconnect the hot water line disconnected in **Step 12**. Use thread sealant tape or pipe dope when making the connection.

31 Turn **ON** the water supply to the water heater at the cold inlet valve. The system will fully pressurize and any leaks at water connections will be apparent. Correct any leaks immediately and dry water heater cabinet with a rag.

Returning Water Heater to Operation

32 Lift the circuit board panel up and lock into place.

33 Install and tighten the screw to the circuit board panel previously removed in **Step**

15.

34 Replace the cabinet cover and secure with the screws previously removed in **Step**

13.

35 Turn **ON** the gas supply to the water heater at the manual gas shut off valve.

36 Restore power to the water heater. The water heater is now ready for operation.

CONDENSATE TRAP REPLACEMENT KIT INSTRUCTIONS

Kit 100371168 Contains:

- Condensate Trap
- Kit Instructions

IMPORTANT: Use only factory authorized replacement parts. **DO NOT USE ELECTRIC SCREWDRIVERS OR DRILLS, HAND TIGHTEN ALL SCREWS TO PREVENT OVER TIGHTENING.** If you lack the necessary skills to properly perform the installation, you should not proceed, but get help from a qualified service technician.

Tools and Materials Required:

- Phillips Screwdriver
- Flat Head Screwdriver
- Towel or Rag
- Bucket or Pan
- Safety Gloves

Preparing Water Heater for Service

1 Disconnect power to the water heater by unplugging it or by turning off the circuit at the breaker box, as appropriate. The power button on the water heater and remote **DOES NOT** disconnect power to the water heater. You must physically disconnect power to the water heater.

2 Shut **OFF** the gas supply to the water heater at the manual gas shut off valve.

3 Shut **OFF** the cold water supply to the water heater at the cold inlet valve.

4 Open all hot water fixtures in the house. When the residual water flow has ceased, close all hot water fixtures. This will depressurize the water heater.

Draining the Water Heater

5 Drain the X3®/Bypass Cartridge. Place a bucket or pan underneath cartridge to collect water during removal.

6 Locate the three (3) screws securing the X3®/Bypass cartridge as shown in Figure 233. Remove the **(A)** M4-12mm screw and the two **(B)** M4-25mm screws from cartridge. Place screws aside in a safe place for reinstallation.

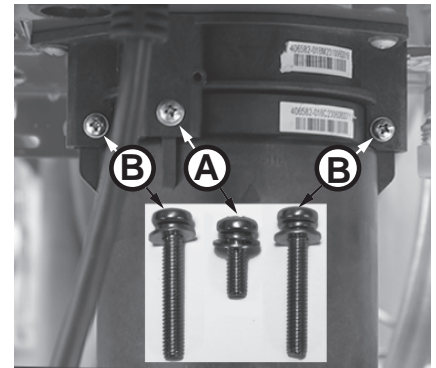

Figure 234 - Identify cartridge screws

7 Pull down to remove the cartridge from the water heater. Wait a few minutes to ensure all water has completely drained.

8 Locate and remove the inlet filter as shown in Figure 235 to drain any residual water left in the system.

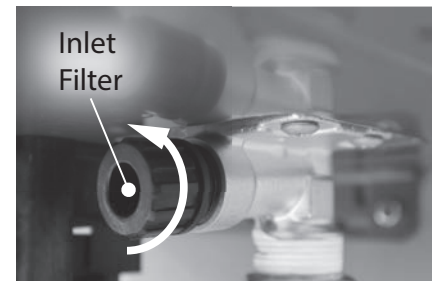

Figure 235 - Inlet filter location

9 Once the water heater has been adequately drained, reinstall inlet filter to water

heater and tighten by hand. Confirm inlet filter is secured to water heater.

- 10 Reinstall the cartridge to the water heater. Insert the cartridge into manifold and secure with the two (2) long screws and one (1) short screw previously set aside in **Step 6**.

NOTICE: The X3® cartridge is keyed to only install in one direction. Align the ▲ on the cartridge with the ▼ on the manifold. When inserting the cartridge, push up until the screw holes align. Some resistance is normal. The bypass cartridge is not keyed and will install in either direction.

- 11 Insert and snug all three (3) screws by hand. Use a screwdriver to tighten the two (B) screws first and lastly tighten screw (A). **DO NOT** use a drill or impact driver to tighten the screws.

Accessing Condensate Trap

- 12 Locate the two (2) screws at the bottom of the cabinet cover. Use a Phillips screwdriver to remove the screws. Place screws aside in a safe place for reinstallation.

- 13 Lift cover up and away from cabinet to gain access to the water heater's internal components.

- 14 Locate the screw securing the control board panel. Use a Phillips screwdriver to remove the screw and place it aside in a safe place for reinstallation. See Figure 236.

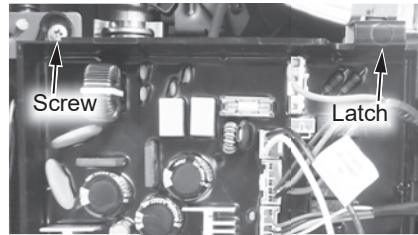

Figure 236 - Control board location

- 15 Press the latch at the top of the circuit board panel and pull the assembly forward from the top. It is hinged at the bottom and can be lowered. The circuit board assembly will hold itself in place.

Removing Condensate Trap

- 16 Locate the condensate trap at the left rear side of the water heater.

- 17 Locate the plastic condensate drain on the bottom left of the water heater. Disconnect drain piping to the plastic condensate drain. Place a bucket or pan underneath to collect water during removal.

- 18 Trace the yellow wires from the condensate trap to the red wiring harness and disconnect them. See Figure 237.

NOTICE: The harness uses a black security clip. Use a small flat blade screw driver to remove and keep this clip for reinstallation. See Figure 237.

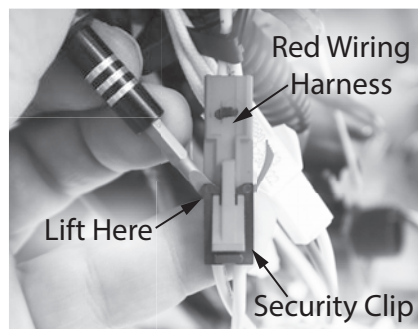

Figure 237 - Red wiring harness clip removal

- 19 Trace the black wires from the condensate trap to the wiring harness marked "LIQUID LEVEL" and disconnect them. See Figure 238.

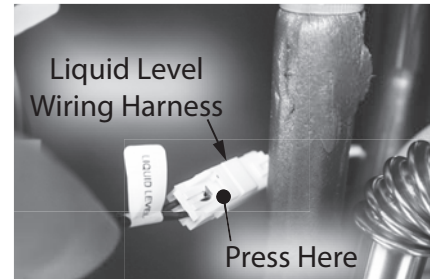

Figure 238 - Liquid level wiring harness location

- 20 Disconnect the black hose from the top of the condensate trap and then from the back of the heat exchanger (HEX). Compress the spring clamp and pull it down along with the black hose. Remove it and dispose of properly. See Figure 239.

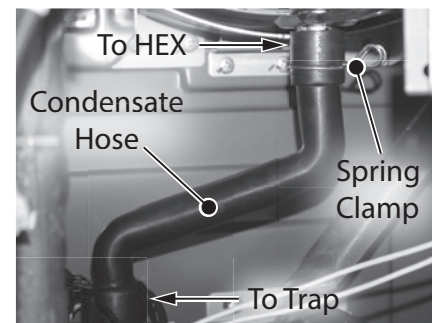

Figure 239 - Condensate hose removal

- 21 Locate the three (3) screws at the back left corner of the cabinet that secure the condensate trap. See Figure 240. Use a Phillips screwdriver to remove the screws. Place screws aside in a safe place for reinstallation.

SERVICE

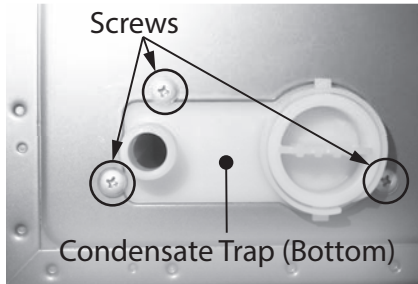

Figure 240 - Location of condensate trap screws.

- 22** Locate the hot outlet pipe and mixing tee connection shown in Figure 241. Remove the spring clip (size 30) and set aside in a safe place for reinstallation.

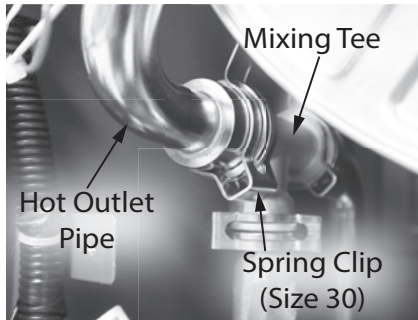

Figure 241 - Mixing tee location

- 23** Move the hot outlet pipe towards the side of the cabinet to allow sufficient room to remove the condensate trap.
- 24** Carefully remove the old condensate trap and dispose of it properly.

Installing New Condensate Trap

- 25** Locate the new condensate trap provided in the kit. Carefully install the new condensate trap.
- 26** Secure the condensate trap with the three (3) screws removed in **Step 21**.

- 27** Route the new red wiring harness to its mate disconnected in **Step 18**.

NOTICE: Carefully insert the black safety clip into the red wiring harness. See Figure 242.

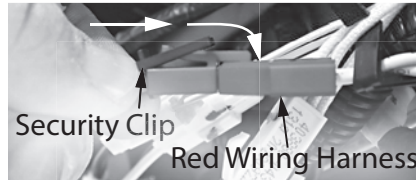

Figure 242 - Reconnecting the wiring harness

- 28** Route and reconnect the black wire marked "LIQUID LEVEL" to its mate removed in **Step 19**.
- 29** Reattach the black hose removed in **Step 20** to the heat exchanger. Make sure the hose is fully seated along with the spring clamp. Reattach the other end of the black hose to the top of the condensate trap. Check the connections to ensure there are fully seated to prevent leaks.
- 30** Reconnect the hot outlet piping to the mixing tee and secure with the spring clip (size 30) removed in **Step 22**.
- 31** Reconnect the condensate drain piping removed in **Step 17**.
- 32** Turn **ON** the cold water supply to the water heater at the cold inlet valve. The system will fully pressurize and any leaks at water connections will be apparent. Correct any leaks immediately and dry water heater cabinet with a rag.

Returning Water Heater to Operation

- 33** Lift the circuit board panel up and lock into place.
- 34** Install and tighten the screw to the circuit board panel previously removed in **Step 14**.
- 35** Replace the cabinet cover and secure with the screws previously removed in **Step 12**.
- 36** Turn **ON** the gas supply to the water heater at the manual gas shut off valve.
- 37** Restore power to the water heater. The water heater is now ready for operation.

CARTRIDGE MANIFOLD AND OUTLET TEE REPLACEMENT KIT INSTRUCTIONS

Kit 100374732 Contains:

- Cartridge Manifold
- Kit Instructions

Kit 100371194 Contains:

- X3® Outlet Tee
- (1x) O-ring (21.8 x 2.4)
- (1x) O-ring (15.5 x 2.5, NBR)
- (1x) O-ring (15.5 x 2.5, EPDM)
- Kit Instructions

IMPORTANT: Use only factory authorized replacement parts. **DO NOT USE ELECTRIC SCREWDRIVERS OR DRILLS, HAND TIGHTEN ALL SCREWS TO PREVENT OVER TIGHTENING.** If you lack the necessary skills to properly perform the installation, you should not proceed, but get help from a qualified service technician.

Tools and Materials Required:

- Phillips Screwdriver
- Towel or Rag
- Bucket or Pan
- Safety Gloves

Preparing Water Heater for Service

- 1 Disconnect power to the water heater by unplugging it or by turning off the circuit at the breaker box, as appropriate. The power button on the water heater and remote **DOES NOT** disconnect power to the water heater. You must physically disconnect power to the water heater.
- 2 Shut **OFF** the cold water supply to the water heater at the cold inlet valve.

- 3 Open all hot water fixtures in the house. When the residual water flow has ceased, close all hot water fixtures. This will depressurize the water heater.

Draining the Water Heater

- 4 Drain the X3®/Bypass Cartridge. Place a bucket or pan underneath cartridge to collect water during removal.
- 5 Locate the three (3) screws securing the X3®/Bypass cartridge as shown in Figure 243. Remove the **(A)** M4-12mm screw and the two **(B)** M4-25mm screws from cartridge. Place screws aside in a safe place for reinstallation.

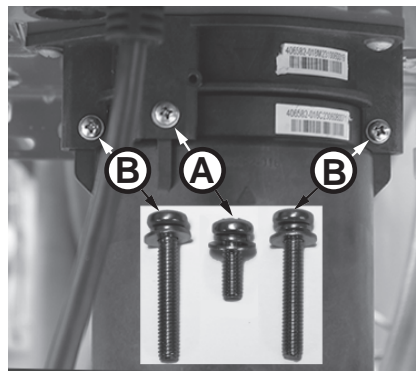

Figure 243 - Identify cartridge screws

- 6 Pull down to remove the cartridge from the water heater. Wait a few minutes to ensure all water has completely drained.
- 7 Locate and remove the inlet filter as shown in Figure 244 to drain any residual water left in the system. Place a bucket or pan underneath inlet filter to collect water during removal.

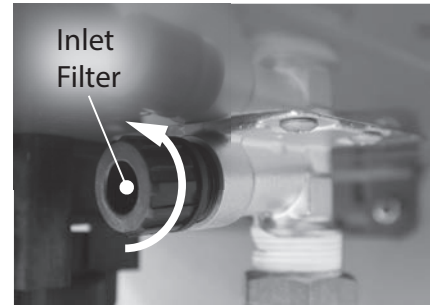

Figure 244 - Locate and remove inlet filter

- 8 Once the water heater has been adequately drained, reinstall inlet filter to water heater and tighten by hand. Confirm inlet filter is secured to water heater.

DO NOT reinstall cartridge.

Accessing Water Heater Components

- 9 Locate the two (2) screws at the bottom of the cabinet cover. Use a Phillips screwdriver to remove the screws. Place screws aside in a safe place for reinstallation.
- 10 Lift cover up and away from cabinet to gain access to the water heater's internal components.
- 11 Locate the screw securing the control board panel as shown in Figure 245. Use a Phillips screwdriver to remove the screw and place it aside in a safe place for reinstallation.

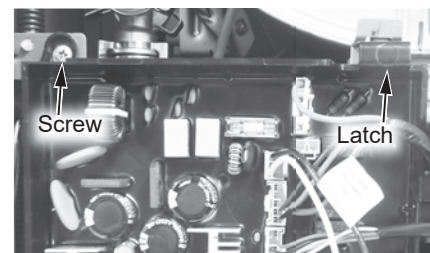

Figure 245 - Control board location

SERVICE

12 Press the latch at the top of the control board panel and pull the assembly forward from the top. It is hinged at the bottom and can be lowered. The control board assembly will hold itself in place.

Preparing Cartridge Manifold and Outlet Tee Assembly for Removal

13 Locate the outlet tee connected to the bypass valve and burner inlet tube as shown in Figure 246 on the following page. Remove the large spring clip (size 30) securing the outlet tee to the burner inlet tube. Remove the small spring clip (size 25) securing the outlet tee to the bypass valve. Place spring clips aside in a safe place for reinstallation. **DO NOT** remove spring clip securing outlet tee to cartridge manifold.

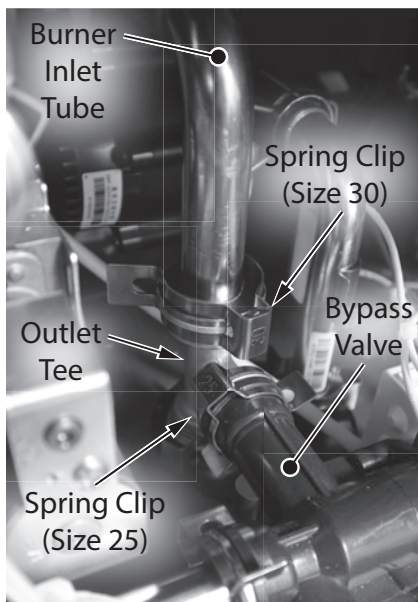

Figure 246 - Remove two spring clips from outlet tee

14 Disconnect bypass valve from outlet tee.

⚠ CAUTION! Water may still be present in the valve assembly. Place a rag under the valve connection points to prevent water from escaping into the water heater cabinet.

15 Locate and remove the small spring clip (size 25) securing the pump outlet tube to cartridge manifold as show in Figure 247. Place spring clip aside in a safe place for reinstallation. Disconnect pump outlet tube from manifold.

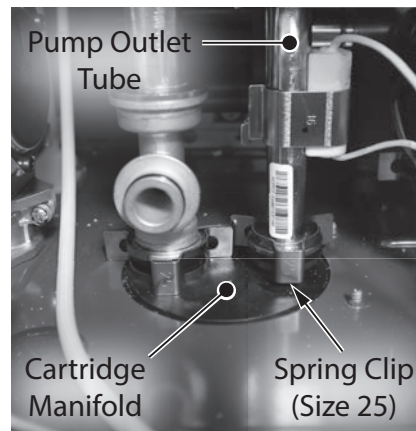

Figure 247 - Remove spring clip from pump outlet tube

The cartridge manifold and outlet tee are now prepared for removal.

Removing Cartridge Manifold and Outlet Tee Assembly

16 Locate the three (3) screws securing the cartridge manifold to the underside of the water heater cabinet as shown in Figure 248. Use a Phillips screwdriver to remove screws. Place screws aside in a safe place for reinstallation.

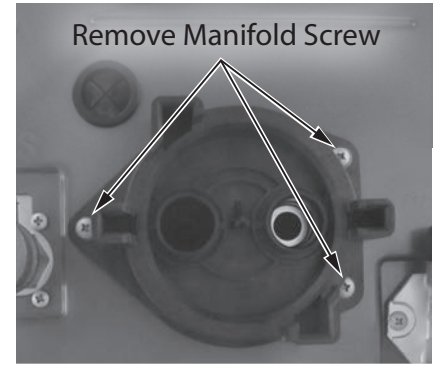

Figure 248 - Remove manifold screws

NOTICE: Rotate spring clip securing outlet tee to cartridge manifold such that the assembly can be easily removed from water heater.

Disconnect the outlet tee from the burner inlet tube and pull manifold down. The assembly will now come free and can be removed from under the water heater cabinet.

17 Remove the small spring clip (size 25) securing outlet tee to cartridge manifold as shown in Figure 249. Place spring clip aside in a safe place for reinstallation. Separate outlet tee from cartridge manifold.

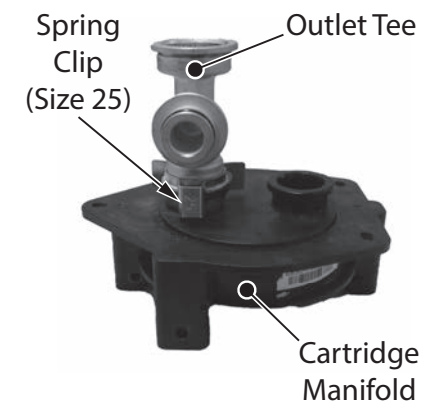

Figure 249 - Remove spring clip from outlet tee and cartridge manifold

(For Kit 100374732 Only)

18 If replacing cartridge manifold, discard old manifold and locate the new cartridge manifold provided in the kit. Attach outlet tee to cartridge manifold and secure with spring clip (size 25) previously removed. Proceed to **Step 21**.

(For Kit 100371194 Only)

19 If replacing outlet tee, discard old tee and locate the new outlet tee provided in the kit. Install one (1) 15.5 x 2.5, NBR O-ring to outlet tee. Replace one (1) 15.5 x 2.5, EPDM O-ring on the cartridge manifold. Replace one (1) 21.8 x 2.4 O-ring on the burner inlet tube. See Figure 250 on the following page for reference.

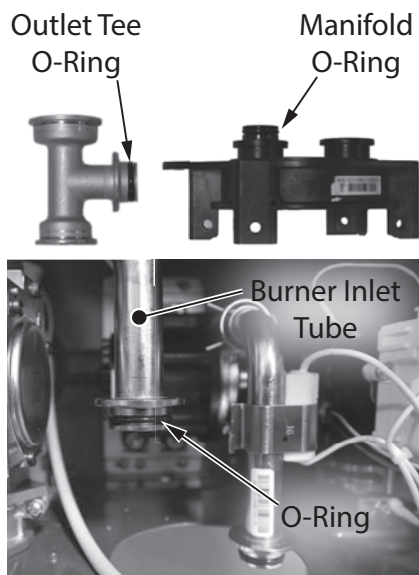

Figure 250 - Replace O-rings

20 Attach new outlet tee to cartridge manifold and secure with spring clip (size 25) previously removed. Proceed to the next step.

Installing Cartridge Manifold and Outlet Tee Assembly

21 Orient cartridge manifold and outlet tee assembly as shown in Figure 251. Install assembly from under the water heater cabinet. Connect the outlet tee to the burner inlet tube and secure with the spring clip (size 30) previously removed in **Step 13**. This will help keep the manifold in place when installing screws.

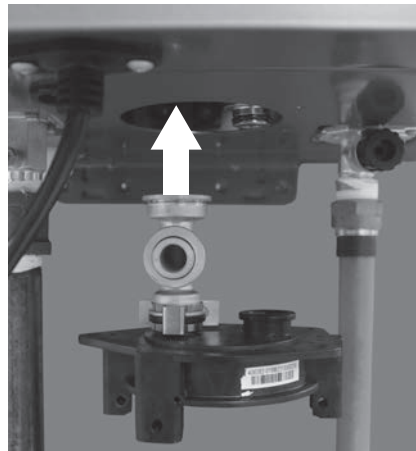

Figure 251 - Orient cartridge manifold and outlet tee

22 Locate the three (3) screws previously removed in **Step 16**. Use screws to secure cartridge manifold to water heater cabinet.

23 With cartridge manifold secured, connect pump outlet tube to manifold and secure with the spring clip (size 25) previously removed in **Step 15**.

24 Connect bypass valve to outlet tee and secure with spring clip (size 25) previously removed in **Step 13**.

Checking for Water Leaks

25 Reinstall the cartridge to the water heater. Locate the screws previously removed in **Step 5**. Insert and snug all three (3) screws by hand.

NOTICE: The X3® cartridge is keyed to only install in one direction. Align the ▲ on the cartridge with the ▼ on the manifold. When inserting the cartridge, push up until the screw holes align. Some resistance is normal. The bypass cartridge is not keyed and will install in either direction.

26 Use a screwdriver to tighten the two (B) screws first and lastly tighten screw (A). **DO NOT** use a drill or impact driver to tighten the screws.

27 Turn **ON** the cold water supply to the water heater at the cold inlet valve. The system will fully pressurize and any leaks at water connections will be apparent. Lower circuit board panel and correct any leaks immediately and dry water heater cabinet with a rag.

Returning Water Heater to Operation

28 Lift the control board panel up and lock into place.

29 Install and tighten the screw to the control board panel previously removed in **Step 11**.

30 Replace the cabinet cover and secure with the screws previously removed in **Step 9**.

31 Restore power to the water heater. The water heater is now ready for operation.

SERVICE

FASTENER MASTER REPLACEMENT KIT INSTRUCTIONS

Kit Contains:

- (2x) Spring Clip (Size 30) (100371100)
- (3x) Spring Clip (Size 25) (100371101)
- (2x) Spring Clip (Size 18-29) (100371084)
- (2x) Retaining Clip (100371083)
- (2x) Slide Fastener (100371094)
- (1x) Spring Clamp (100371057)
- (2x) Thermistor Clip (100371019)
- Kit Instructions

IMPORTANT: Use only factory authorized replacement parts. **DO NOT USE ELECTRIC SCREWDRIVERS OR DRILLS, HAND TIGHTEN ALL SCREWS TO PREVENT OVERTIGHTENING.** If you lack the necessary skills to properly perform the installation, you should not proceed, but get help from a qualified service technician.

NOTE: Some components in Figures have been removed to provide clarity. Use the component overview See Figure 266 to reference the general location of fasteners. Diagram callouts reference the Figures in the following sections.

Spring Clips (Size 30)

- 1 Spring clips (size 30) are located on the mixing tee, outlet water tube, and inlet burner tube.

See Figure 252, Figure 254, and Figure 254 for reference.

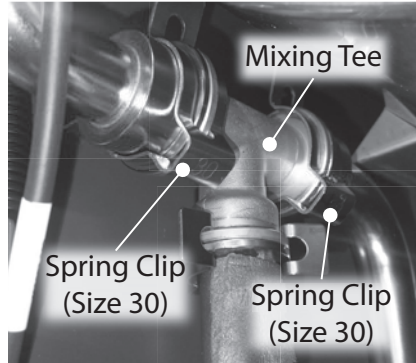

Figure 252 - Spring Clips (Size 30), Mixing Tee (A1)

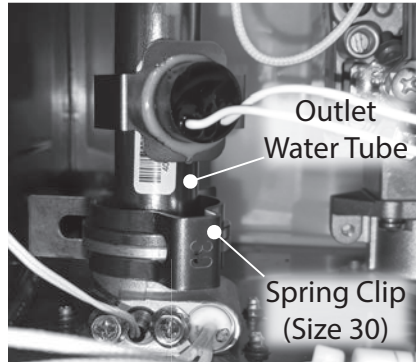

Figure 253 - Spring Clip (Size 30), Outlet Water Tube (A2)

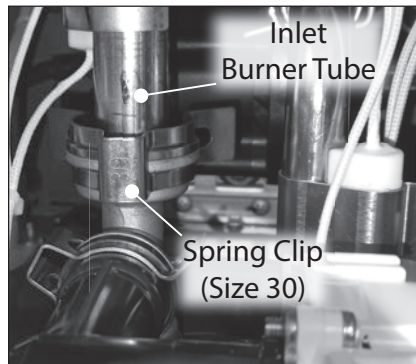

Figure 254 - Spring Clip (Size 30), Inlet Burner Tube (A3)

Spring Clips (Size 25)

- 2 Spring clips (size 25) are located on the mixing tee, bypass valve, flow control valve, outlet tee, and outlet pump tube.

See Figure 255, Figure 256, Figure 257, and Figure 258 for reference.



Figure 255 - Spring Clip (Size 25), Mixing Tee (B1)

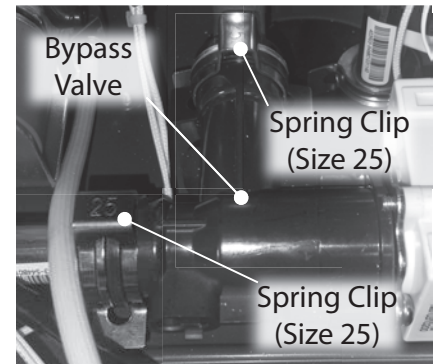

Figure 256 - Spring Clips (Size 25), Bypass Valve (B2)

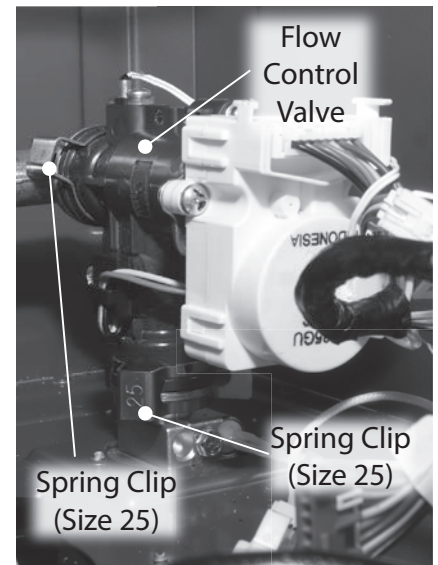

Figure 257 - Spring Clips (Size 25), Flow Control Valve (B3)

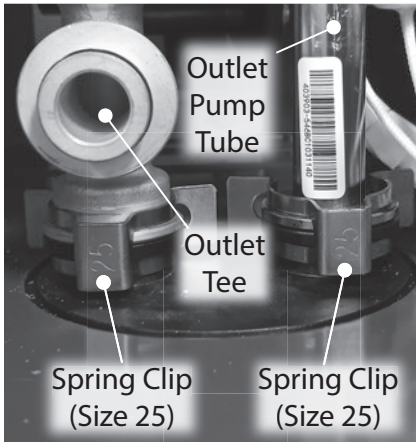

Figure 258 - Spring Clips (Size 25), Outlet Tee & Outlet Pump Tube

Spring Clips (Keyed)

3 Spring clips (18-29) are located on the gas tube. Some fasteners may be provided unmarked.

See Figure 259 for reference.

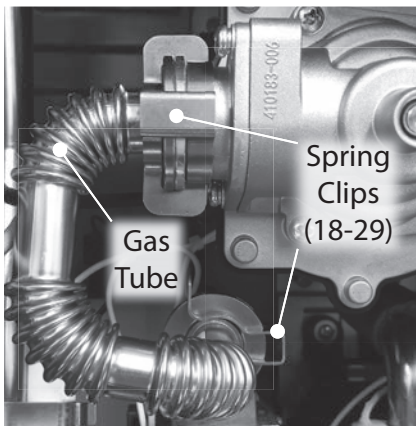

Figure 259 - Spring Clips (18-29), Gas Tube

Retaining Clips

4 Retaining clips are located on the water pump.

See Figure 260 for reference.

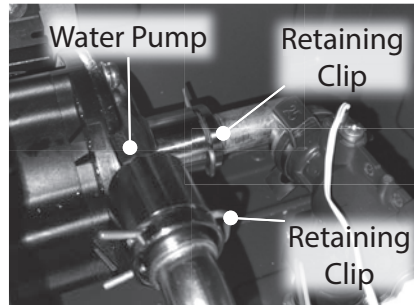

Figure 260 - Retaining Clips, Water Pump

Slide Fasteners

5 Slide fasteners are located on the inlet and outlet burner tubes.

See Figure 261 & Figure 262 for reference.

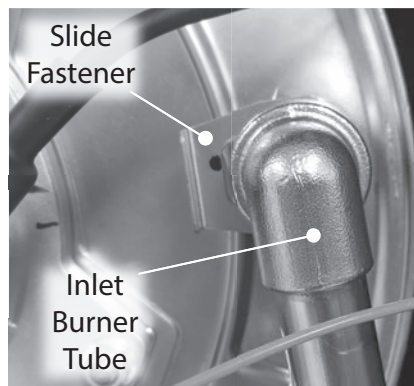

Figure 261 - Slide Fastener, Inlet Burner Tube

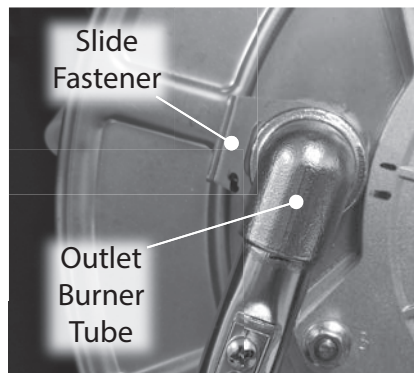

Figure 262 - Slide Fastener, Outlet Burner Tube

Spring Clamp

6 Spring clamp is located on the condensate trap hose connection at the heat exchanger.

See Figure 263 for reference.

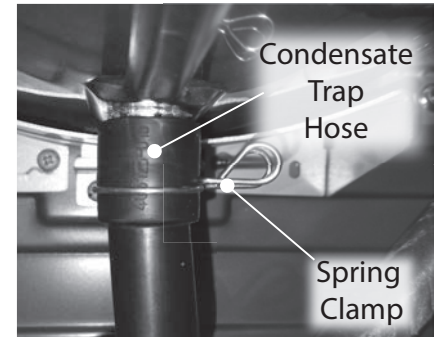

Figure 263 - Spring Clamp, Condensate Hose

Thermistor Clip

7 Thermistor clips are located on the outlet burner tube and exhaust thermistor (behind top install bracket).

See Figure 264 & Figure 265 for reference.

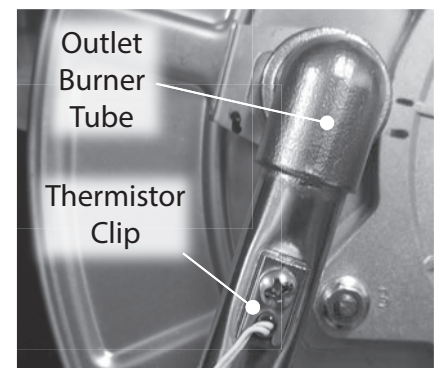

Figure 264 - Thermistor Clip, Outlet Burner Tube

SERVICE

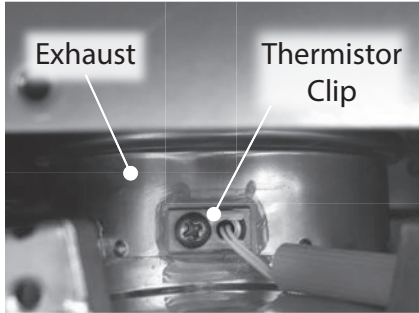

Figure 265 - Thermistor Clip, Exhaust Thermistor

NOTICE: Diagram callouts reference the Figures in the previous sections.

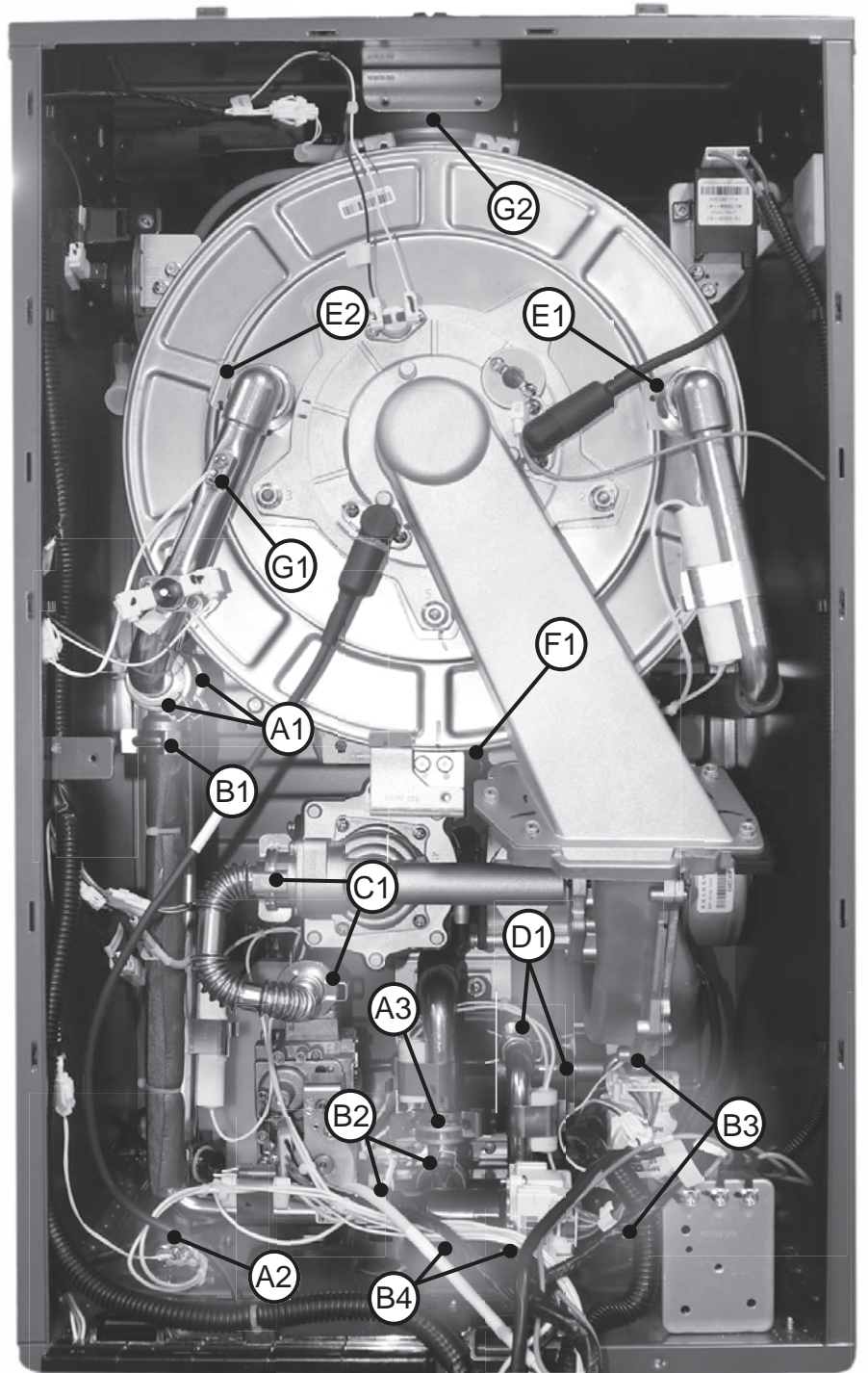

Figure 266 - Fastener Location Guide

O-Ring Replacement Kit Instructions

IMPORTANT: Use only factory authorized replacement parts. **DO NOT USE ELECTRIC SCREWDRIVERS OR DRILLS, HAND TIGHTEN ALL SCREWS TO PREVENT OVER TIGHTENING.** If you lack the necessary skills to properly perform the installation, you should not proceed, but get help from a qualified service technician.

WARNING!

This kit shall be installed by a qualified service agency in accordance with the manufacturer's instructions and all applicable codes and requirements of the authority having jurisdiction. The information in these instructions must be followed to minimize the risk of fire or explosion or to prevent property damage, personal injury or death. The qualified service agency is responsible for the proper installation of this kit.

NOTICE: Use Figure 268 to reference the location of O-rings provided in the kit.

Preparing Water Heater for Service

1 Disconnect power to the water heater by unplugging it or by turning off the circuit at the breaker box, as appropriate. The power button on the water heater and remote **DOES NOT** disconnect power to the water heater. You must physically disconnect power to the water heater.

- 2** Shut **OFF** the gas supply to the water heater at the manual gas shut off valve (to replace O-rings G1-G4 only).
- 3** Shut **OFF** the cold water supply to the water heater at the cold inlet valve (to change O-rings W1-W8 only).

Draining the Water Heater (O-rings W1-W8 only)

- 4** Open all hot water fixtures in the house. When the residual water flow has ceased, close all hot water fixtures. This will depressurize the water heater.
- 5** Drain the X3®/Bypass Cartridge and inlet filter. Place a bucket or pan underneath cartridge and inlet filter to collect water during removal. Reference the Service Handbook for detailed instructions on how to properly drain the water heater. Install cartridge and inlet filter back to water heater and proceed.

Accessing Water Heater Components

- 6** Locate the two (2) screws at the bottom of the cabinet cover. Use a Phillips screwdriver to remove the screws. Place screws aside in a safe place for reinstallation.
- 7** Lift cover up and away from cabinet to gain access to the water heater's internal components.
- 8** Locate the screw securing the control board panel as shown in Figure 267. Use a Phillips screwdriver to remove the screw and place it aside in a safe place for reinstallation.

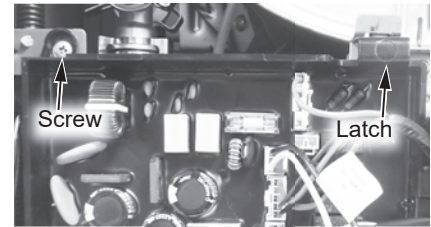

Figure 267 - Control board location

The water heater is now ready to be serviced. Replace O-rings as needed.

Checking for Water Leaks (O-rings W1-W8 only)

- 9** Turn **ON** the cold water supply to the water heater at the cold inlet valve. The system will fully pressurize and any leaks at water connections will be apparent. Correct any leaks immediately and dry water heater cabinet with a rag.
- 10** Restore power to the water heater.

Checking for Gas Leaks (O-rings G1-G4 only)

- 11** Turn **ON** the gas supply to the water heater at the manual gas shut off valve if previously turned off.
- 12** Restore power to the water heater.
- 13** Open all hot water fixtures in the house. This will initiate the call for heat at the water heater.
- 14** Check for leaks around the bottom gas valve connection and exhaust thermistor only. Use a small, soft-bristled brush to apply a hand dishwashing soap and water mixture (1 part soap to 15 parts water) or children's soap bubbles around the bottom gas valve connection. If any leaks are detected (which will appear as small bubbles), resecure the connection and recheck for leaks.

SERVICE

Returning Water Heater to Operation

- 15** Lift the control board panel up and lock into place.
- 16** Install and tighten the screw to the control board panel previously removed in **Step 8**.
- 17** Replace the cabinet cover and secure with the screws previously removed in **Step 6**.

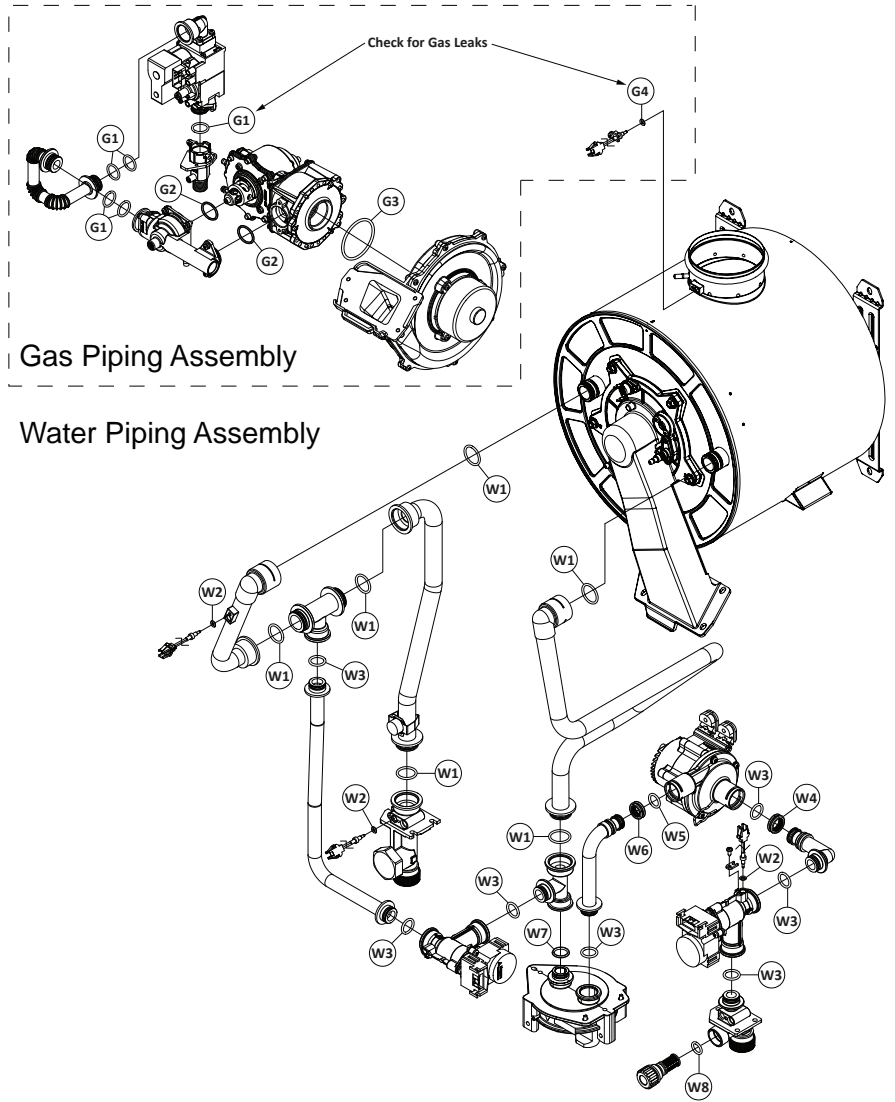
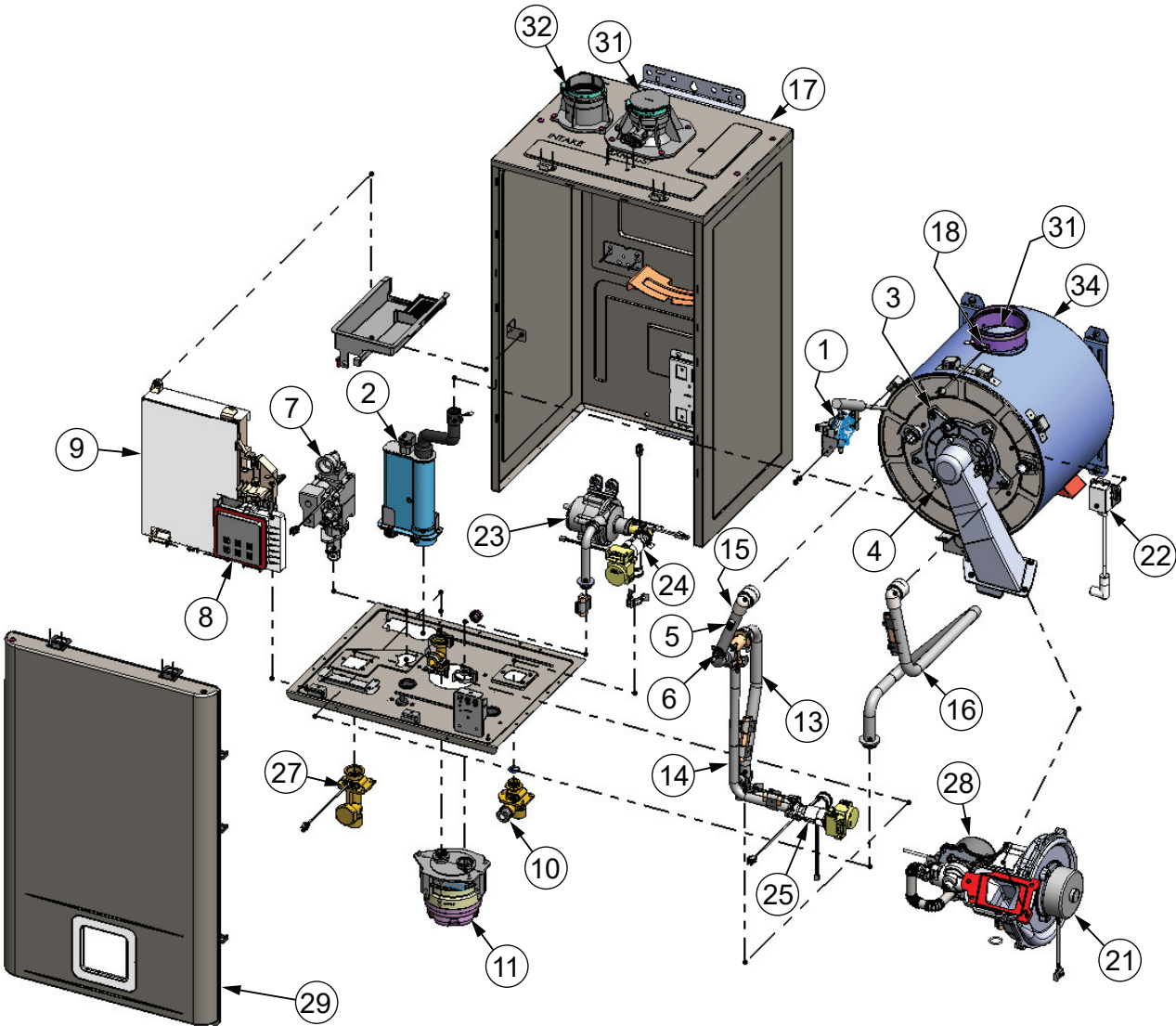

Figure 268 - O-Ring Replacement Guide

COMPONENT LIST



NOTES

COMPONENT LIST

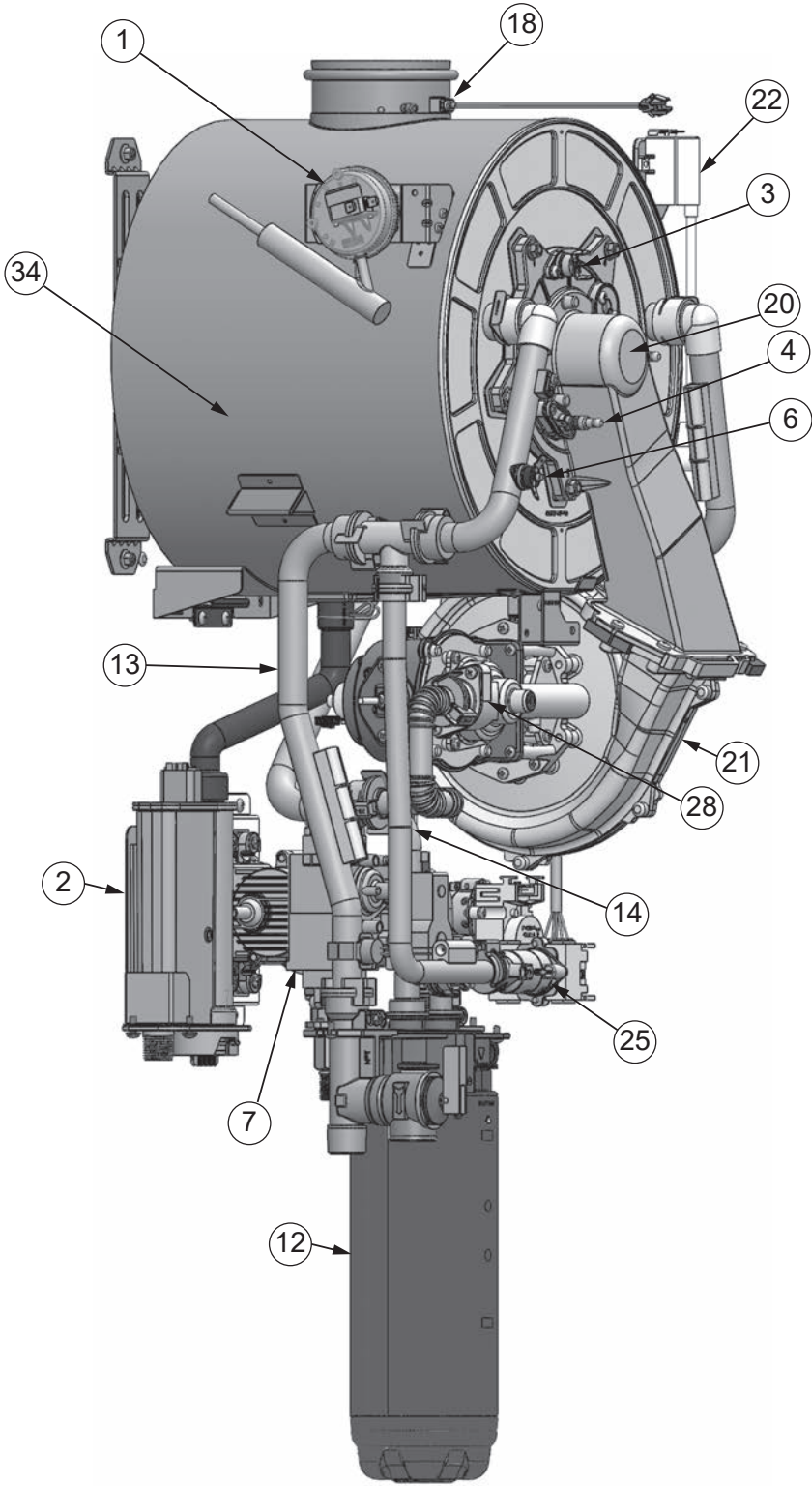

COMPONENT DATA

COMPONENT LIST

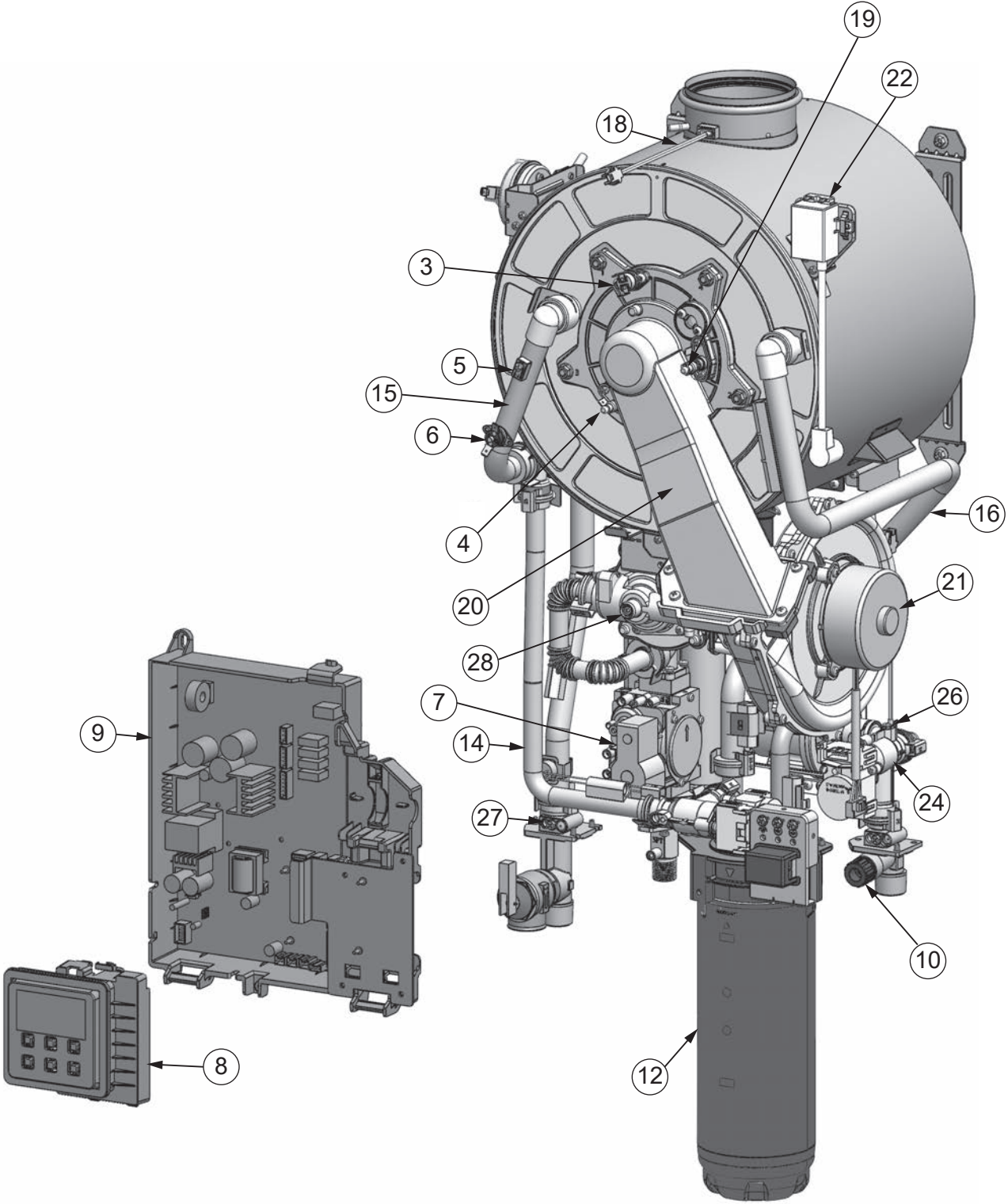

COMPONENT LIST

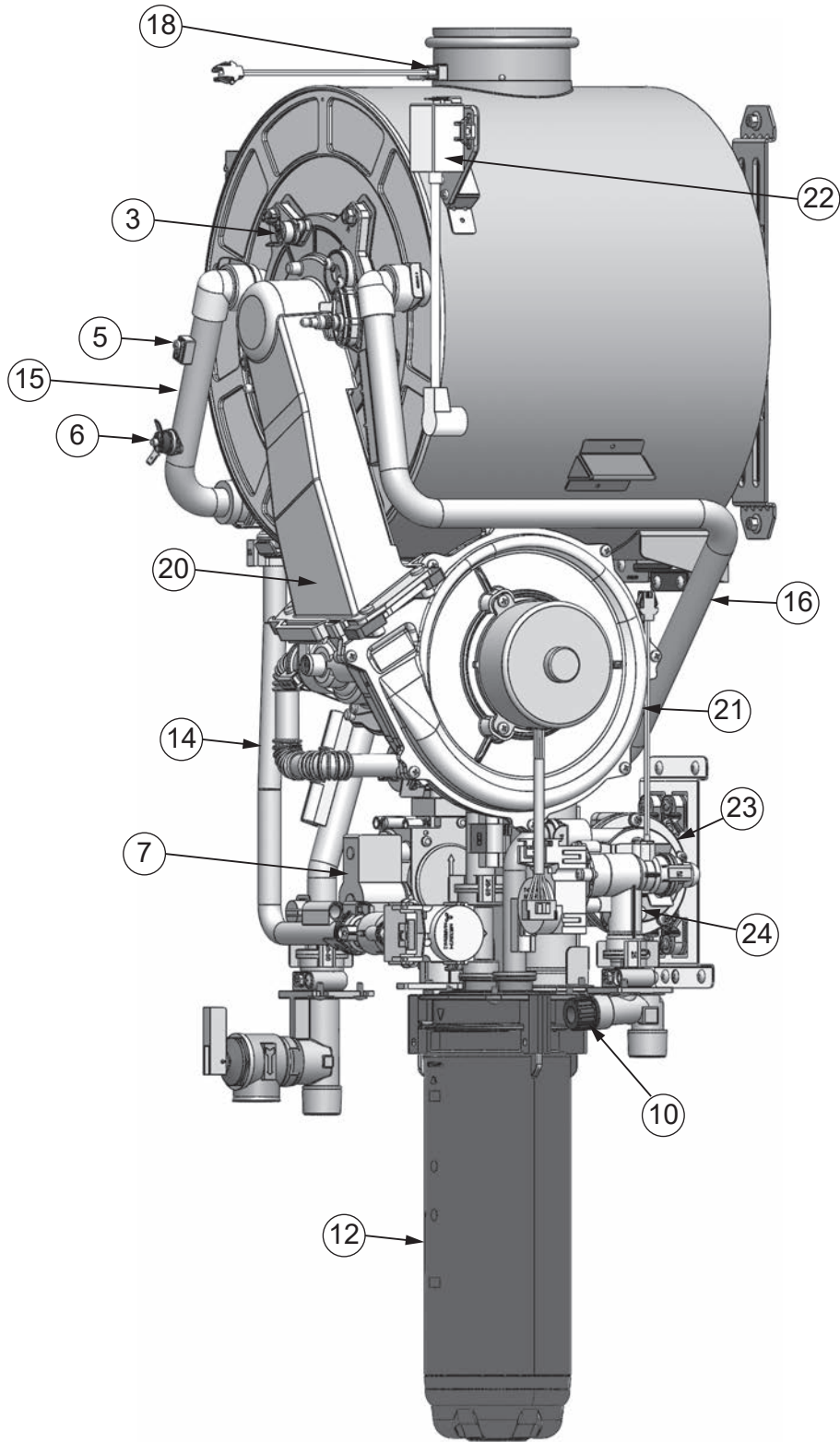

COMPONENT LIST

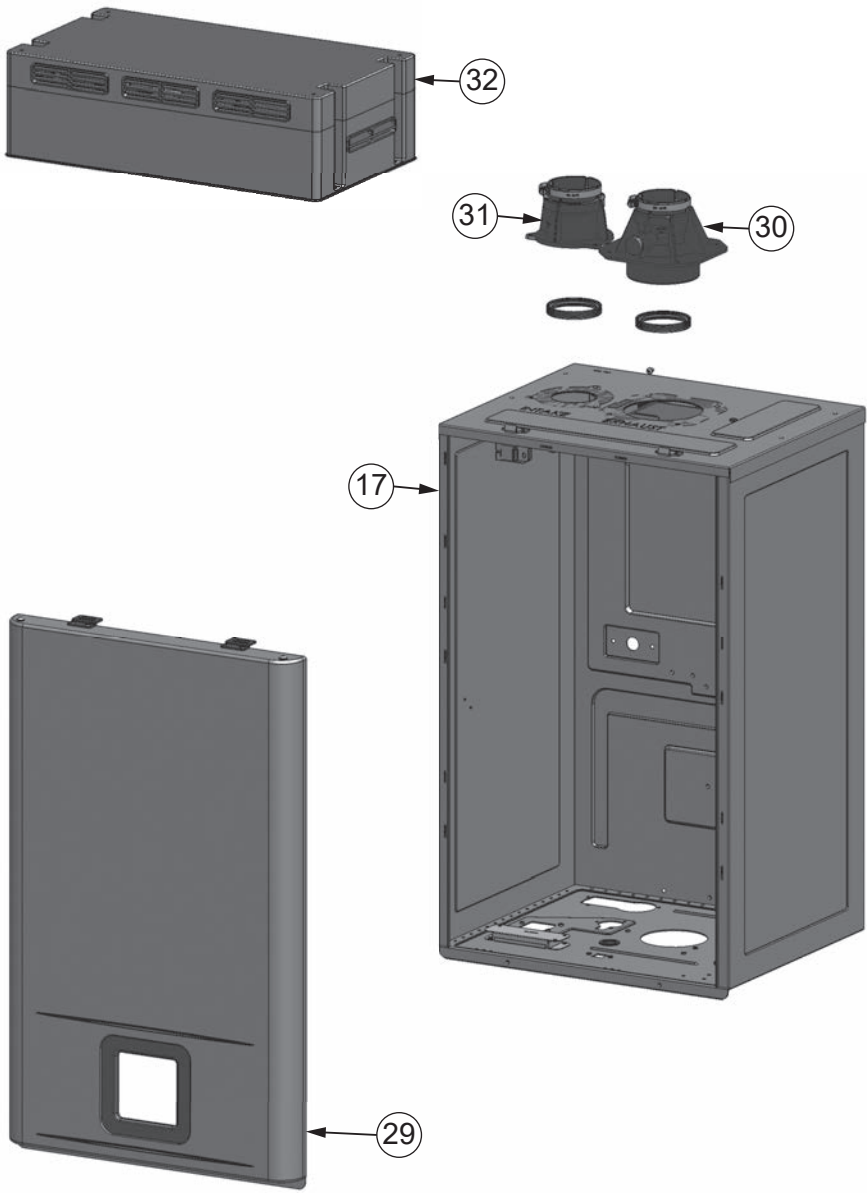

COMPONENT LIST

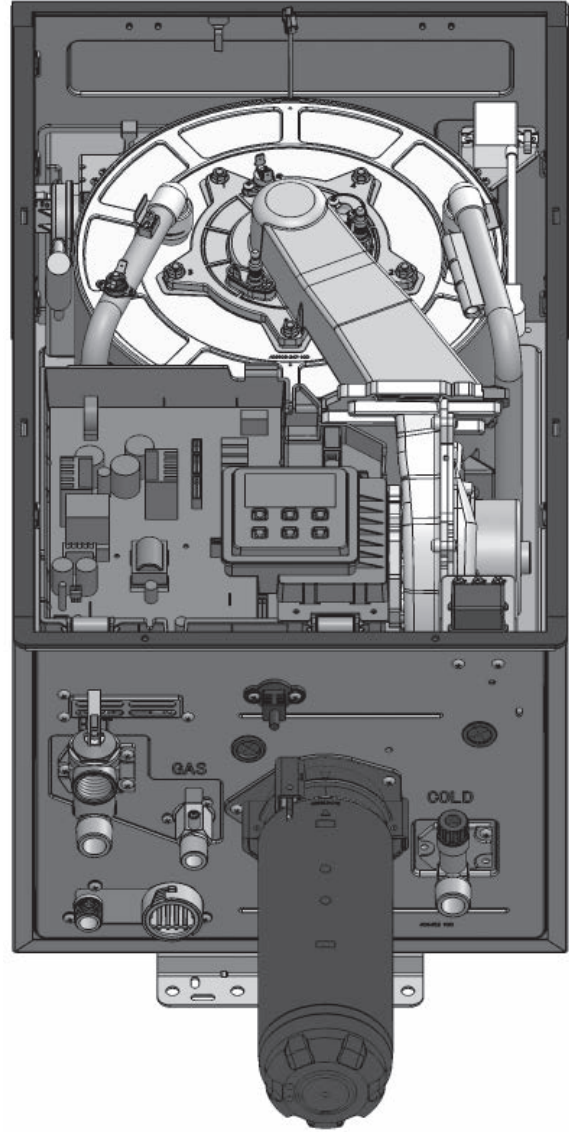
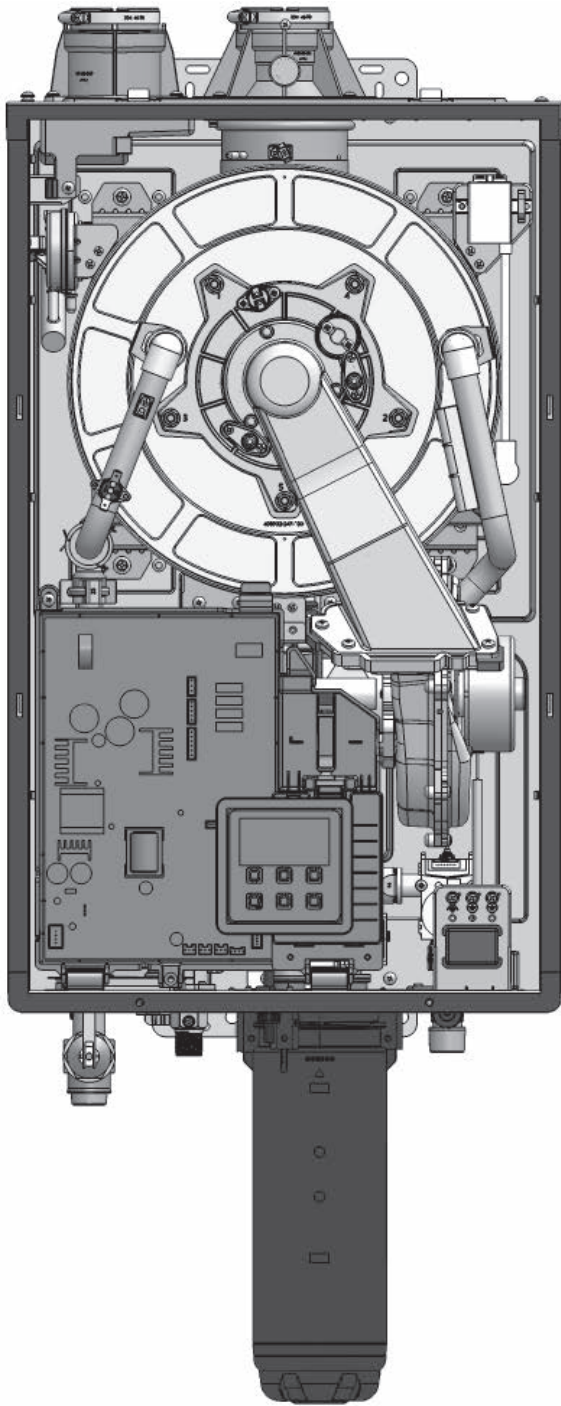

COMPONENT LIST

When ordering repair parts, always give the following information:

1. Model and serial numbers. This info should be on the left side of the water heater
2. Part(s) description

Item No.	Component List
1	AIR PRESSURE SWITCH
2	CONDENSATE TRAP
3	BURNER DOOR HI-LIMIT
4	FLAME SENSOR
5	HEAT EXCHANGER THERMISTOR
6	HI-LIMIT SWITCH (MANUAL RESET)
7	GAS VALVE
8	USER INTERFACE MODULE (UIM)
9	PRINTED CIRCUIT BOARD
10	INLET FILTER
11	BYPASS CARTRIDGE (NOT SHOWN)
12	X3® CARTRIDGE
13	OUTLET WATER TUBE
14	BYPASS WATER TUBE
15	HEAT EXCHANGER OUTLET WATER TUBE
16	INLET WATER TUBE
17	CASE (FRONT COVER NOT SHOWN FOR CLARITY)
18	EXHAUST THERMISTOR
19	IGNITOR ROD
20	BURNER ASSEMBLY
21	FAN
22	IGNITOR
23	PUMP
24	FLOW SENSOR/FLOW CONTROL VALVE ASSEMBLY
25	BYPASS VALVE
26	INLET THERMISTOR
27	OUTLET THERMISTOR
28	VENTURI ASSEMBLY
29	CASE FRONT COVER
30	EXHAUST PORT
31	INLET PORT
32	OUTDOOR VENT CAP
33	HEAT EXCHANGER ASSEMBLY

WIRING DIAGRAM

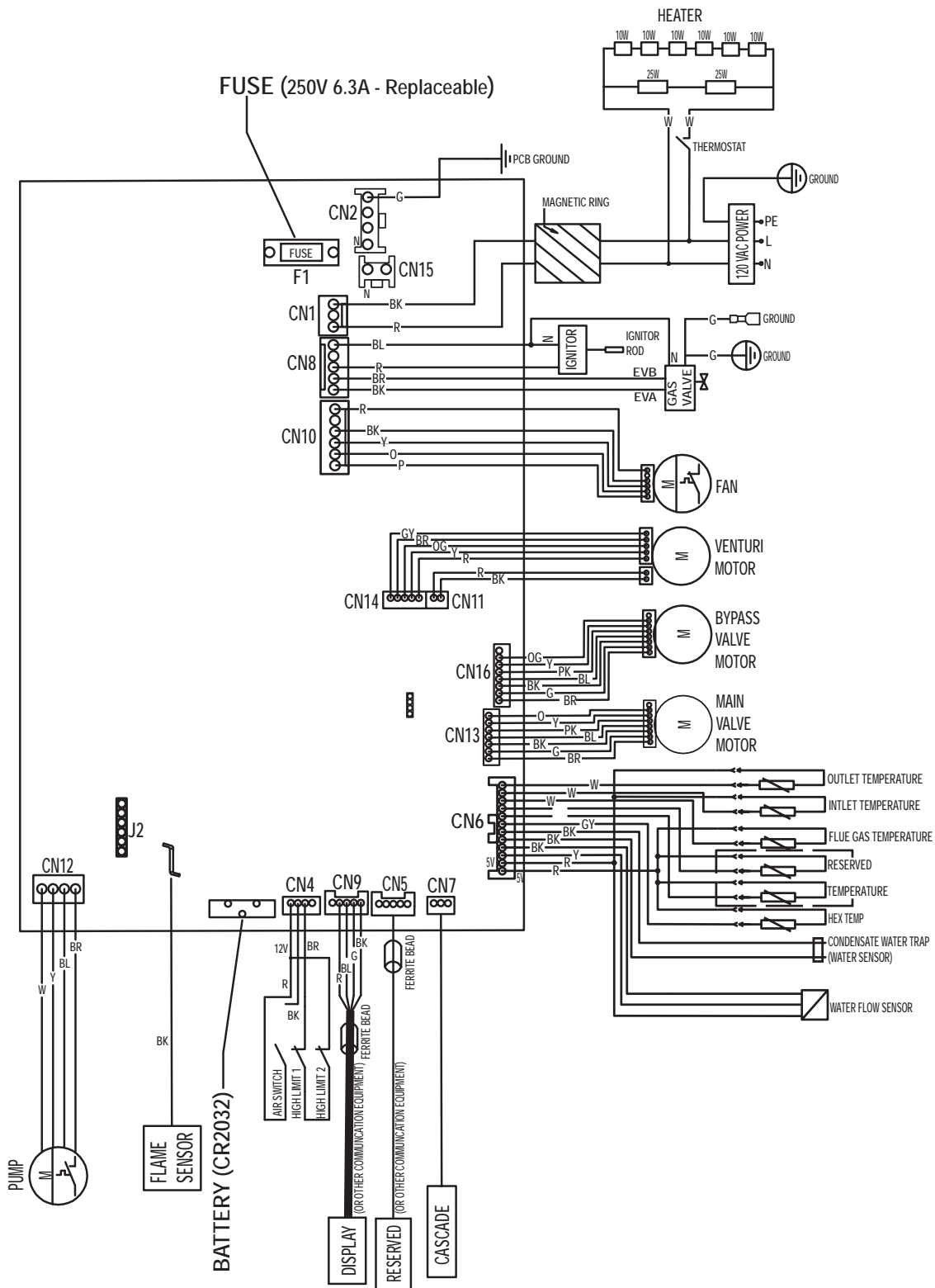

THERMISTOR RESISTANCE VS TEMPERATURE CHARTS

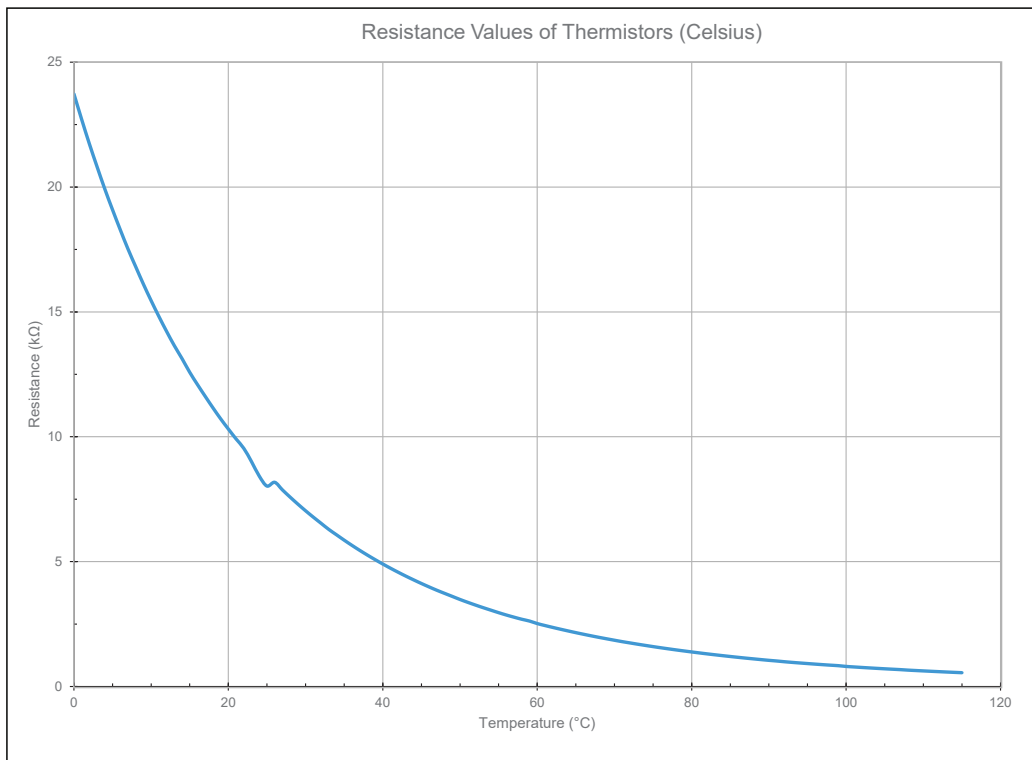
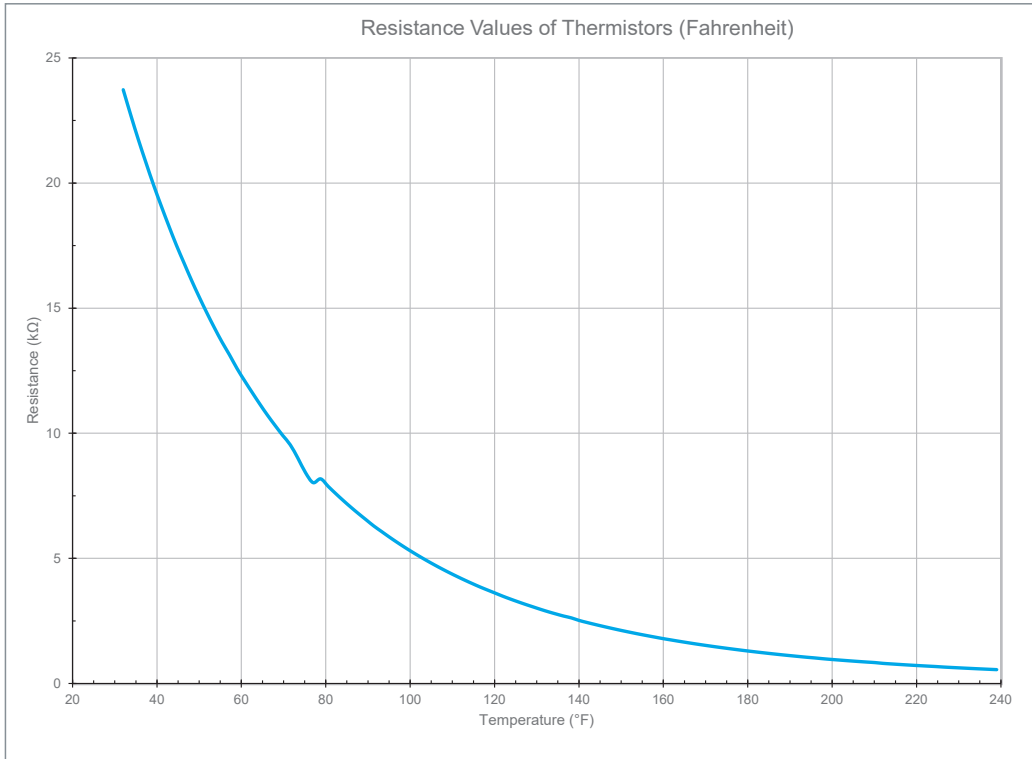

NOTES

NOTES

NOTES

